



## FCC Information and Copyright

This equipment has been tested and found to comply with the limits of a Class B digital device, pursuant to Part 15 of the FCC Rules. These limits are designed to provide reasonable protection against harmful interference in a residential installation. This equipment generates, uses, and can radiate radio frequency energy and, if not installed and used in accordance with the instructions, may cause harmful interference to radio communications. There is no guarantee that interference will not occur in a particular installation.

The vendor makes no representations or warranties with respect to the contents here and specially disclaims any implied warranties of merchantability or fitness for any purpose. Further the vendor reserves the right to revise this publication and to make changes to the contents here without obligation to notify any party beforehand.

Duplication of this publication, in part or in whole, is not allowed without first obtaining the vendor's approval in writing.

The content of this user's manual is subject to be changed without notice and we will not be responsible for any mistakes found in this user's manual. All the brand and product names are trademarks of their respective companies.



Dichiarazione di conformità sintetica  
Ai sensi dell'art. 2 comma 3 del D.M. 275 del  
30/10/2002

Si dichiara che questo prodotto è conforme  
alle normative vigenti e soddisfa i requisiti  
essenziali richiesti dalle direttive  
2004/108/CE, 2006/95/CE e 1999/05/CE  
quando ad esso applicabili

Short Declaration of conformity

We declare this product is complying with the  
laws in force and meeting all the essential  
requirements as specified by the directives  
2004/108/CE, 2006/95/CE and 1999/05/CE  
whenever these laws may be applied

# Table Of Contents

<b>FCC Information and Copyright .....</b>	<b>1</b>
<b>Chapter 1: Introduction.....</b>	<b>3</b>
1.1 Before You Start .....	3
1.2 Package Checklist.....	3
1.3 Specifications.....	4
1.4 Rear Panel Connectors.....	5
1.5 Motherboard Layout .....	6
<b>Chapter 2: Hardware installation.....</b>	<b>7</b>
2.1 Install Central Processing Unit (CPU) .....	7
2.2 Install a Heatsink.....	9
2.3 Connect Cooling Fans .....	10
2.4 Install System Memory .....	10
2.5 Expansion Slots.....	12
2.6 Jumper & Switch Setting.....	13
2.7 Headers & Connectors.....	14
<b>Chapter 3: UEFI BIOS &amp; Software.....</b>	<b>18</b>
3.1 UEFI BIOS Setup.....	18
3.2 BIOS Update.....	18
3.3 Software.....	22
<b>Chapter 4: Useful help.....</b>	<b>27</b>
4.1 Driver Installation .....	27
4.2 AMI BIOS Beep Code.....	28
4.3 AMI BIOS post code .....	28
4.4 Troubleshooting.....	30
4.5 RAID Functions.....	31
<b>APPENDIX I: Specifications in Other Languages .....</b>	<b>33</b>
Arabic.....	33
German.....	34
Russian.....	35
Spanish .....	36
Thai.....	37
<b>APPENDIX II: Charger Boost II Compatible Devices .....</b>	<b>38</b>

# Chapter 1: Introduction

## 1.1 Before You Start

Thank you for choosing our product. Before you start installing the motherboard, please make sure you follow the instructions below:

- Prepare a dry and stable working environment with sufficient lighting.
- Always disconnect the computer from power outlet before operation.
- Before you take the motherboard out from anti-static bag, ground yourself properly by touching any safely grounded appliance, or use grounded wrist strap to remove the static charge.
- Avoid touching the components on motherboard or the rear side of the board unless necessary. Hold the board on the edge, do not try to bend or flex the board.
- Do not leave any unfastened small parts inside the case after installation. Loose parts will cause short circuits which may damage the equipment.
- Keep the computer from dangerous area, such as heat source, humid air and water.
- The operating temperatures of the computer should be 0 to 45 degrees Celsius.
- To avoid injury, be careful of:
  - Sharp pins on headers and connectors
  - Rough edges and sharp corners on the chassis
  - Damage to wires that could cause a short circuit

## 1.2 Package Checklist

- Serial ATA Cable x2
- Rear I/O Panel for ATX Case x1
- User's Manual x1
- Fully Setup Driver DVD x1

---

**Note**

- » *The package contents may be different due to the sales region or models in which it was sold. For more information about the standard package in your region, please contact your dealer or sales representative.*
-

## 1.3 Specifications

Specifications	
CPU Support	Socket 1151 for Intel® Core i7 / i5 / i3 / Pentium / Celeron processor Maximum CPU TDP (Thermal Design Power): 95Watt * Please refer to <a href="http://www.biostar.com.tw">www.biostar.com.tw</a> for CPU support list.
Chipset	INTEL® Z170 (Hi-Fi Z170Z5); INTEL® B150 (Hi-Fi B150Z5)
Memory	Supports Dual Channel DDR3L 1600/1333 2x DDR3L DIMM Memory Slot, Max. Supports up to 16 GB Memory Supports Dual Channel DDR4 2133/1866 2x DDR4 DIMM Memory Slot, Max. Supports up to 32 GB Memory * Please refer to <a href="http://www.biostar.com.tw">www.biostar.com.tw</a> for Memory support list. ** The motherboard will be damaged when you install DDR3L and DDR4 memory modules at same time.
Storage	INTEL® Z170: 1x SATA Express Connector (16Gb/s), 4x SATA III Connector supports RAID 0,1,10, 5 & AHCI INTEL® B150: 1x SATA Express Connector (16Gb/s), 4x SATA III Connector supports AHCI
LAN	Intel I219V, 1x 10/ 100/ 1000 Mb/s auto negotiation, Half / Full duplex capability
Audio Codec	ALC892, 7.1 Channels, High Definition Audio, Biostar Hi-Fi (Front+Rear)
USB	6x USB 3.0 port (4 on rear I/Os and 2 via internal header) 6x USB 2.0 port (2 on rear I/Os and 4 via internal header)
Expansion Slots	3x PCI Slot 1x PCIe 3.0 x1 Slot 1x PCIe 3.0 x16 Slot (x4) 1x PCIe 3.0 x16 Slot (x16)
Rear I/Os	1x PS/2 Keyboard/ Mouse 1x DVI-D Port 1x VGA Port 1x HDMI Port 1x LAN port 2x USB 2.0 Port 4x USB 3.0 Port 3x Audio Jack
Internal I/Os	1x SATA Express Connector 4x SATA III Connector 2x USB 2.0 Header 1x USB 3.0 Header 1x 8-Pin Power Connector 1x 24-Pin Power Connector 1x CPU Fan Connector 2x System Fan Connector 1x Front Panel Header 1x Front Audio Header 1x Clear CMOS Header 1x S/PDIF out Connector 1x COM Port Header
Form Factor	ATX Form Factor, 305 mm x 225 mm
OS Support	Windows 7/ 8.1(64bit)/ 10(64bit) Biostar reserves the right to add or remove support for any OS with or without notice.

## 1.4 Rear Panel Connectors

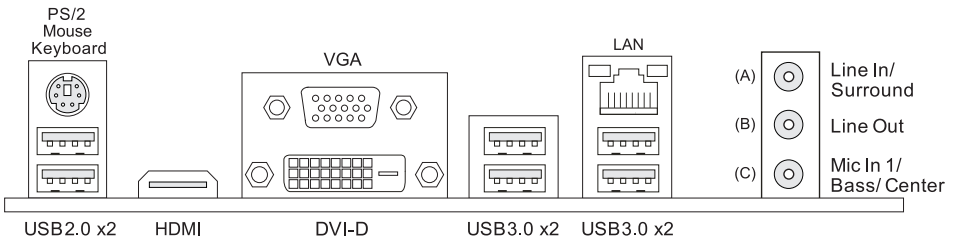

### Note

- » *VGA, HDMI & DVI-D ports only work with an Intel® integrated Graphics Processor.*
- » *Maximum resolution*  
*HDMI: 4096 x 2160 @24Hz, compliant with HDMI 1.4a*  
*VGA: 1920 x 1200 @60Hz*  
*DVI-D: 1920 x 1200 @60Hz*
- » *The mainboard supports three onboard display outputs at same time and the display output configuration can be selected in Intel graphics driver utility.*

### The 2/ 4/ 5.1/ 7.1-channel configuration

Audio Port	2-channel	4-channel	5.1 channel	7.1 channel
<b>A (Rear Panel)</b>	Line In	Rear Speaker Out	Rear Speaker Out	Rear Speaker Out
<b>B (Rear Panel)</b>	Line Out	Front Speaker Out	Front Speaker Out	Front Speaker Out
<b>C (Rear Panel)</b>	Mic In	Mic In	Center/Subwoofer Out	Center/Subwoofer Out
<b>Green (Front Panel)</b>	--	--	--	Side Speaker Out

## 1.5 Motherboard Layout

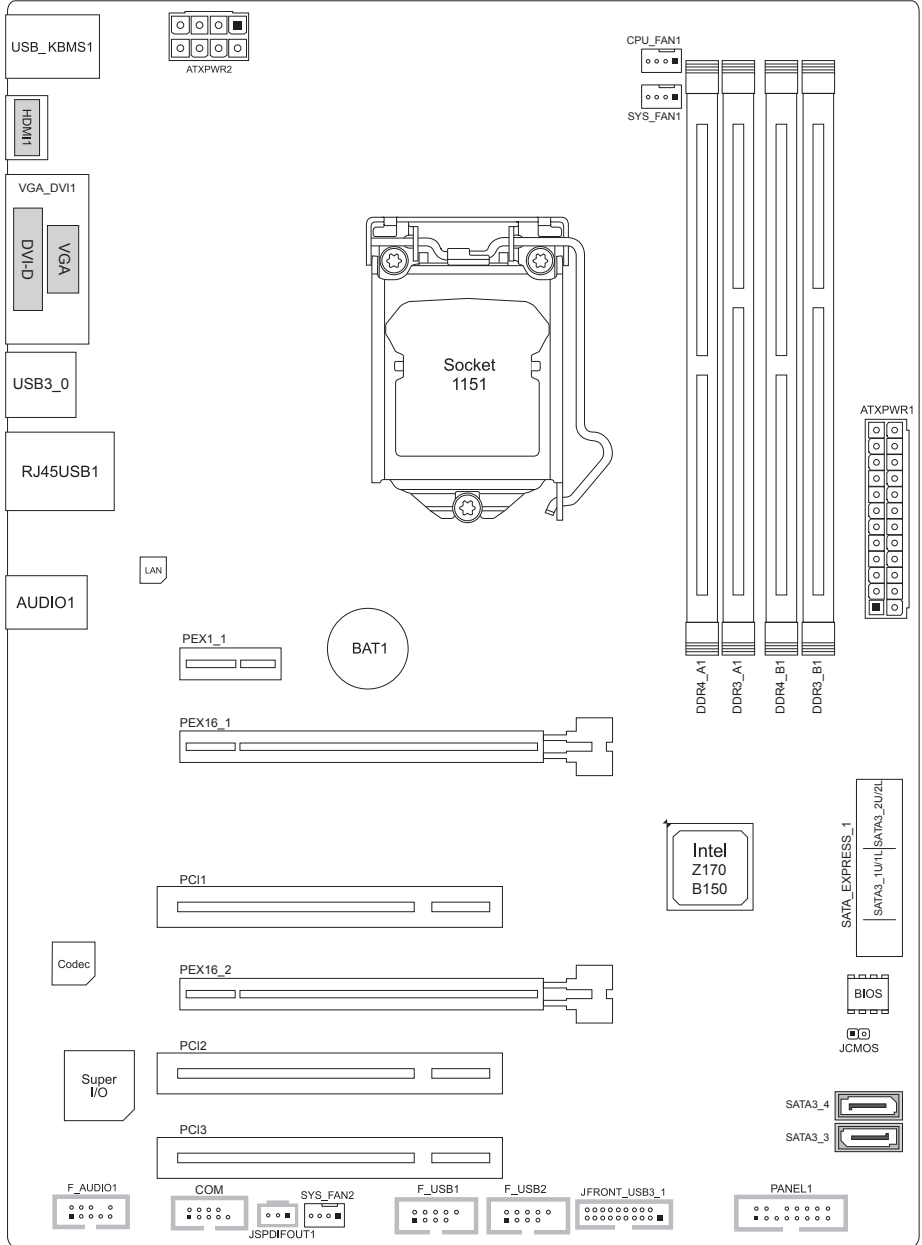

**Note**

» ■ represents the 1st pin.

## Chapter 2: Hardware installation

### 2.1 Install Central Processing Unit (CPU)

Step 1: Locate the CPU socket on the motherboard

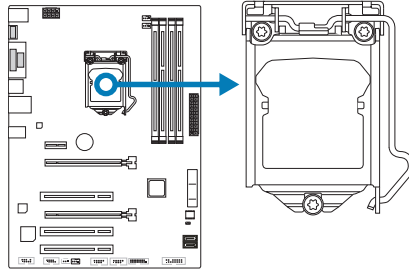

► **Note**

- » Remove pin cap before installation, and make good preservation for future use. When the CPU is removed, cover the pin cap on the empty socket to ensure pin legs won't be damaged.
- » The motherboard might equip with two different types of pin cap. Please refer below instruction to remove the pin cap.

Step 2: Pull the socket locking lever out from the socket and then raise the lever up.

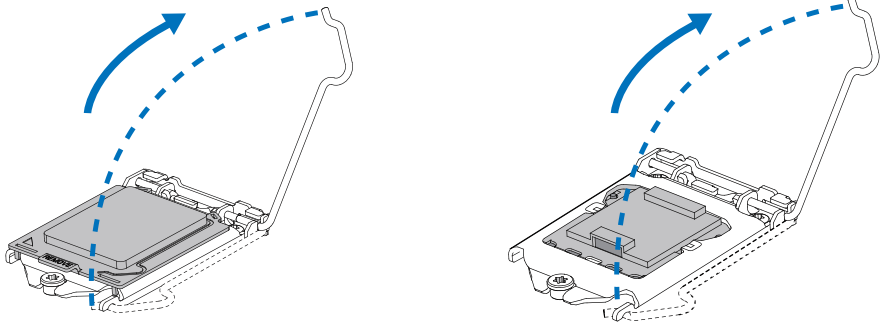

Step 3: Remove the Pin Cap.

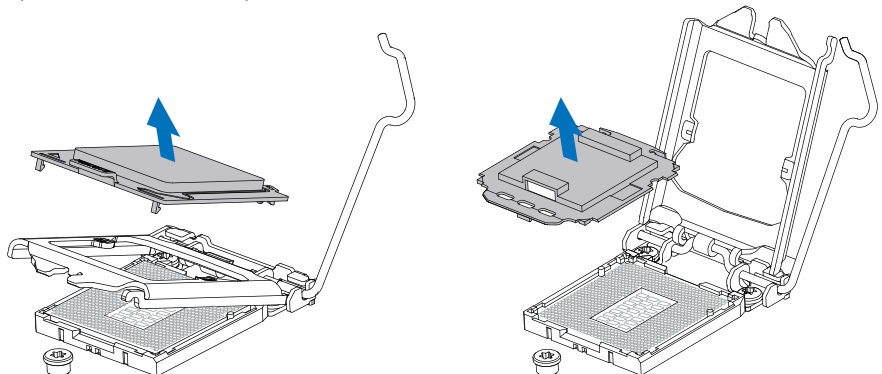

Step 4: Hold processor with your thumb and index fingers, oriented as shown. Align the notches with the socket. Lower the processor straight down without tilting or sliding the processor in the socket.

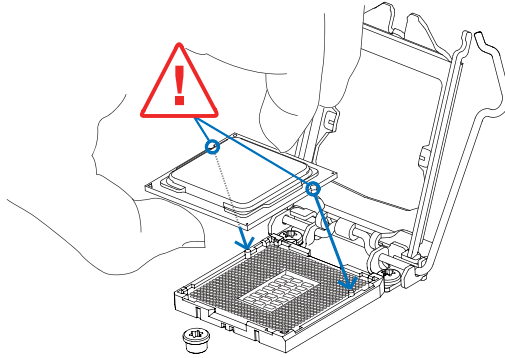

Step 5: Hold the CPU down firmly, and then lower the lever to locked position to complete the installation.

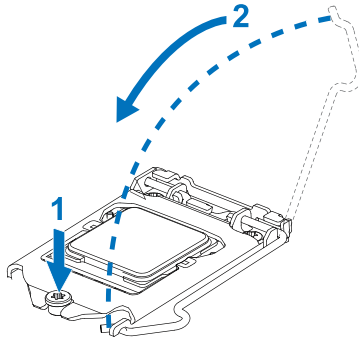

---

**Note**

- » Ensure that you install the correct CPU designed for LGA1151 socket.
  - » The CPU fits only in one correct orientation. Do not force the CPU into the socket to prevent damaging the CPU.
-



## 2.2 Install a Heatsink

Step 1: Place the CPU fan assembly on top of the installed CPU and make sure that the four fasteners match the motherboard holes. Orient the assembly and make the fan cable is closest to the CPU fan connector.

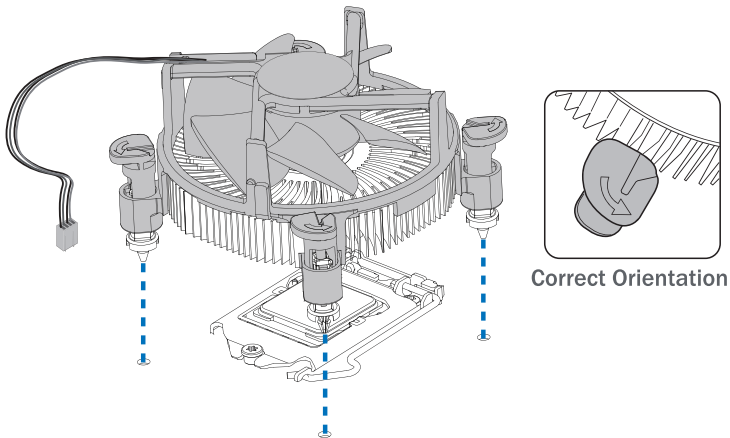

Step 2: Press down two fasteners at one time in a diagonal sequence to secure the CPU fan assembly in place. As each fastener locks into position a click should be heard.

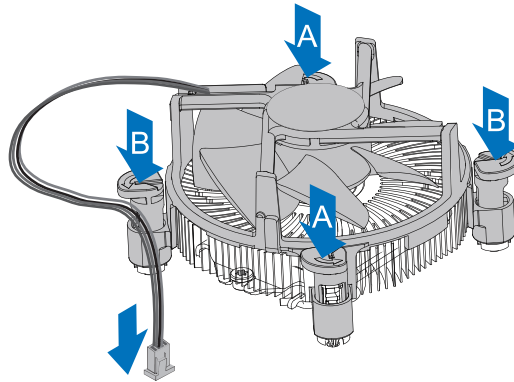

### Note

- » Apply the thermal interface material on the CPU before heatsink installation, if necessary.
- » Do not forget to connect the CPU fan connector.
- » For proper installation, please kindly refer to the installation manual of your CPU heatsink.

## 2.3 Connect Cooling Fans

These fan headers support cooling-fans built in the computer. The fan cable and connector may be different according to the fan manufacturer.

### CPU\_FAN1: CPU Fan Header

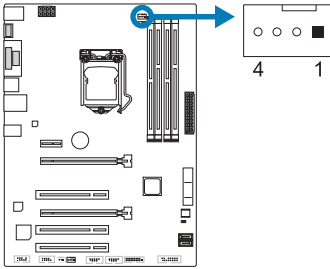

Pin	Assignment
1	Ground
2	+12V
3	FAN RPM rate sense
4	Smart Fan Control (By Fan)

### SYS\_FAN1/2: System Fan Header

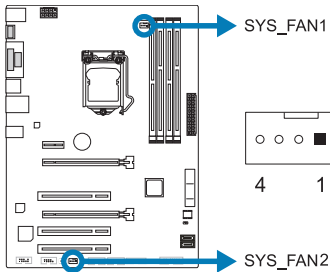

Pin	Assignment
1	Ground
2	+12V
3	FAN RPM rate sense
4	Smart Fan Control (By Fan)

#### Note

- » CPU\_FAN1, SYS\_FAN1/2 support 4-pin and 3-pin head connectors. When connecting with wires onto connectors, please note that the red wire is the positive and should be connected to pin#2, and the black wire is Ground and should be connected to pin#1(GND).

## 2.4 Install System Memory

### DDR3L/DDR4 Modules

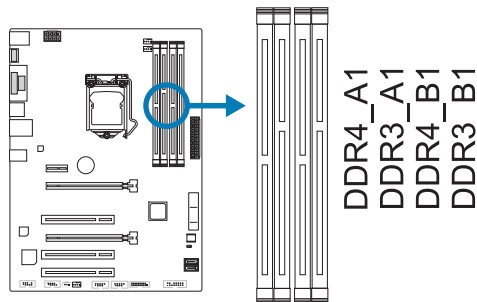

Step 1: Unlock a DIMM slot by pressing the retaining clips outward. Align a DIMM on the slot such that the notch on the DIMM matches the break on the slot.

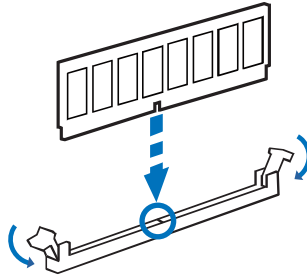

Step 2: Insert the DIMM vertically and firmly into the slot until the retaining clips snap back in place and the DIMM is properly seated.

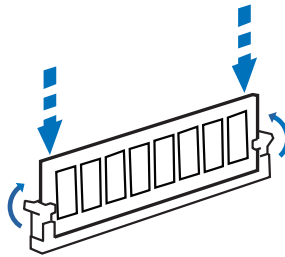

#### Note

- » If the DIMM does not go in smoothly, do not force it. Pull it all the way out and try again.
- » The motherboard will be damaged when you install DDR3L and DDR4 memory modules at same time.

## Memory Capacity

DIMM Socket Location	DDR3L Module	Total Memory Size
DDR3_A1	4GB/8GB	Max is 16GB.
DDR3_B1	4GB/8GB	
DIMM Socket Location	DDR4 Module	Total Memory Size
DDR4_A1	4GB/8GB/16GB	Max is 32GB.
DDR4_B1	4GB/8GB/16GB	

## Dual Channel Memory Installation

Please refer to the following requirements to activate Dual Channel function:  
Install memory module of the same density in pairs, shown in the table.

Dual Channel Status	DDR3_A1	DDR3_B1	DDR4_A1	DDR4_B1
Enabled	O	O	X	X
Enabled	X	X	O	O

(O means memory installed, X means memory not installed.)

#### Note

- » When installing more than one memory module, we recommend to use the same brand and capacity memory on this motherboard.

## 2.5 Expansion Slots

### PCI1/PCI2/PCI3: Peripheral Component Interconnect Slots

- This motherboard is equipped with 2 standard PCI slots. PCI stands for Peripheral Component Interconnect, and it is a bus standard for expansion cards.

### PEX16\_1: PCI-Express Gen3 x16 Slot

- PCI-Express 3.0 compliant.
- Maximum theoretical realized bandwidth of 16GB/s simultaneously per direction, for an aggregate of 32GB/s totally.

### PEX16\_2: PCI-Express Gen3 x4 Slot

- PCI-Express 3.0 compliant.
- Data transfer bandwidth up to 4GB/s per direction; 8GB/s in total

### PEX1\_1: PCI-Express Gen3 x1 Slot

- PCI-Express 3.0 compliant.
- Data transfer bandwidth up to 1GB/s per direction; 2GB/s in total

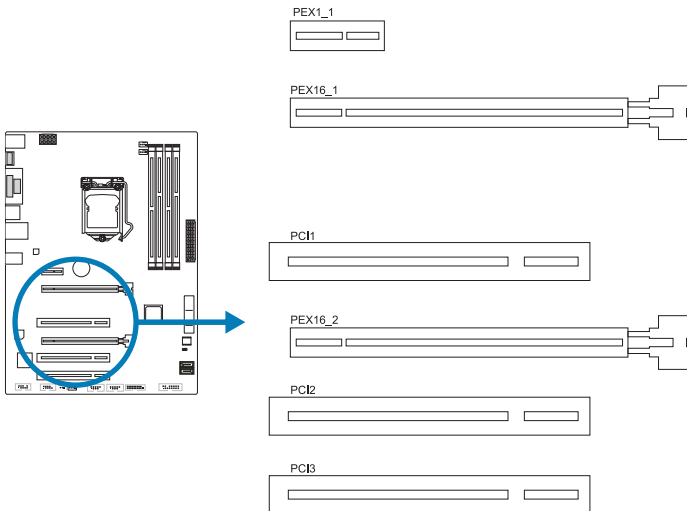

### Install an Expansion Card

You can install your expansion card by following steps:

- Read the related expansion card's instruction document before install the expansion card into the computer.
- Remove your computer's chassis cover, screws and slot bracket from the computer.
- Place a card in the expansion slot and press down on the card until it is completely seated in the slot.
- Secure the card's metal bracket to the chassis back panel with a screw.
- Replace your computer's chassis cover.
- Power on the computer, if necessary, change BIOS settings for the expansion card.
- Install related driver for the expansion card.

## 2.6 Jumper & Switch Setting

The illustration shows how to set up jumpers. When the jumper cap is placed on pins, the jumper is “close”, if not, that means the jumper is “open”.

Pin opened



Pin closed



Pin 1-2 closed



### JCMOS1: Clear CMOS Jumper

The jumper allows users to restore the BIOS safe setting and the CMOS data. Please carefully follow the procedures to avoid damaging the motherboard.

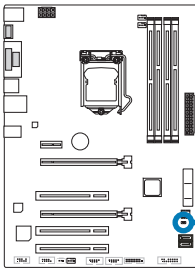

1 2  
  
 Pin 1-2 Open: Normal Operation (Default)

1 2  
  
 Pin 1-2 Close: Clear CMOS data

#### Clear CMOS Procedures:

1. Remove AC power line.
2. Set the jumper to “Pin 1-2 close”, you can use a metal object like a screwdriver to touch the two pins.
3. Wait for five seconds.
4. After clearing the CMOS values, be sure the jumper is “Pin 1-2 open”.
5. Power on the AC.
6. Load Optimal Defaults and save settings in CMOS.

## 2.7 Headers & Connectors

### ATXPWR1: ATX Power Source Connector

For better compatibility, we recommend to use a standard ATX 24-pin power supply for this connector. Make sure to find the correct orientation before plugging the connector.

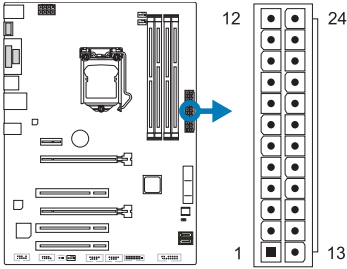

Pin	Assignment	Pin	Assignment
13	+3.3V	1	+3.3V
14	-12V	2	+3.3V
15	Ground	3	Ground
16	PS_ON	4	+5V
17	Ground	5	Ground
18	Ground	6	+5V
19	Ground	7	Ground
20	NC	8	PW_OK
21	+5V	9	Standby Voltage+5V
22	+5V	10	+12V
23	+5V	11	+12V
24	Ground	12	+3.3V

### ATXPWR2: ATX Power Source Connector

The connector provides +12V to the CPU power circuit. If the CPU power plug is 4-pin, please plug it into Pin 1-2-5-6 of ATXPWR2.

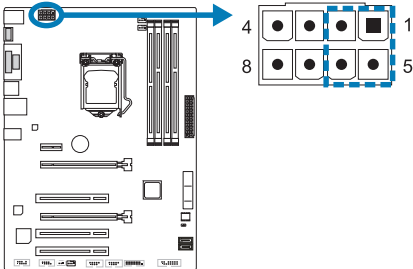

Pin	Assignment
1	+12V
2	+12V
3	+12V
4	+12V
5	Ground
6	Ground
7	Ground
8	Ground

#### Note

- » Before you power on the system, please make sure that both ATXPWR1 and ATXPWR2 connectors have been plugged-in.
- » Insufficient power supplied to the system may result in instability or the peripherals not functioning properly. Use of a PSU with a higher power output is recommended when configuring a system with more power-consuming devices.

### PANEL1: Front Panel Header

This 16-pin header includes Power-on, Reset, HDD LED, Power LED, and speaker connection.

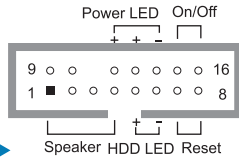
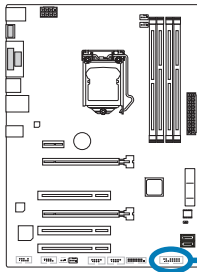

Pin	Assignment	Function	Pin	Assignment	Function
1	+5V	Speaker Connector	9	N/A	Power LED
2	N/A		10	N/A	
3	N/A		11	N/A	
4	Speaker	Hard drive LED	12	Power LED (+)	Power-on button
5	HDD LED (+)		13	Power LED (+)	
6	HDD LED (-)	Reset button	14	Power LED (-)	Reset button
7	Ground		15	Power button	
8	Reset control		16	Ground	

### SATA\_Express\_1: SATA Express Connector

Each SATA Express connector can support one SATA Express device or two SATA devices.

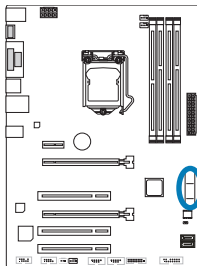

Pin	Assignment	Pin	Assignment
S1/S8	Ground	P1	Reserved
S2/S9	TX+	P2	PERST#
S3/S10	TX-	P3	CLKREQ#/DEVSLP
S4/S11	Ground	P4	IFDet
S5/S12	RX-		
S6/S13	RX+		
S7/S14	Ground		

### SATA3\_3/3\_4: Serial ATA Connectors

These connectors connect to SATA hard disk drives via SATA cables.

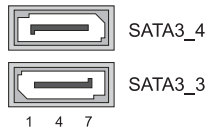
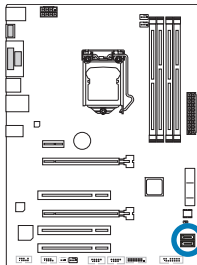

Pin	Assignment
1	Ground
2	TX+
3	TX-
4	Ground
5	RX-
6	RX+
7	Ground

### JFRONT\_USB3\_1: Header for USB 3.0 Ports at Front Panel

This header allows user to add additional USB ports on the PC front panel, and also can be connected with a wide range of external peripherals.

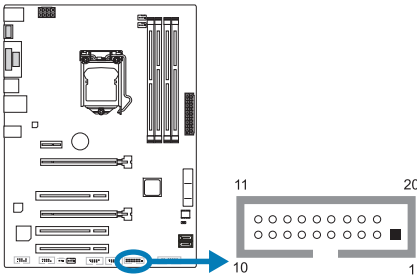

Pin	Assignment	Pin	Assignment
1	VBUS0	11	D2+
2	SSRX1-	12	D2-
3	SSRX1+	13	Ground
4	Ground	14	SSTX2+
5	SSTX1-	15	SSTX2-
6	SSTX1+	16	Ground
7	Ground	17	SSRX2+
8	D1-	18	SSRX2-
9	D1+	19	VBUS1
10	ID	20	Key

#### Note

- » This connector supports Biostar Charger Booster II technology which boosts the charging time of your USB-powered devices.
- » The charging mode can be selected in BIOS setup menu or Charger Booster II program.

### F\_USB1/2: Header for USB 2.0 Ports at Front Panel

This header allows user to add additional USB ports on the PC front panel, and also can be connected with a wide range of external peripherals.

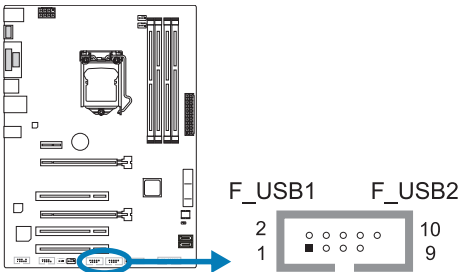

Pin	Assignment
1	+5V (fused)
2	+5V (fused)
3	USB-
4	USB-
5	USB+
6	USB+
7	Ground
8	Ground
9	Key
10	NC

### JSPDIFOUT1: Digital Audio-out Connector

The connector is for connecting the S/PDIF output bracket.

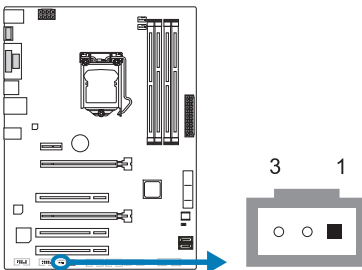

Pin	Assignment
1	+5V
2	SPDIF_OUT
3	Ground



## F\_AUDIO1: Front Panel Audio Header

This header allows user to connect the chassis-mount front panel audio I/O which supports HD and AC'97 audio standards.

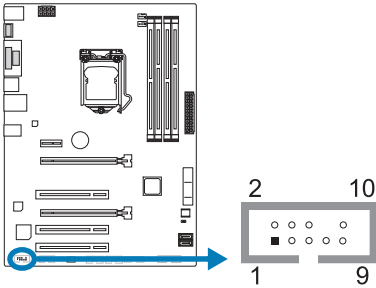

HD Audio		AC'97	
Pin	Assignment	Pin	Assignment
1	Mic Left in	1	Mic In
2	Ground	2	Ground
3	Mic Right in	3	Mic Power
4	GPIO	4	Audio Power
5	Right line in	5	RT Line Out
6	Jack Sense	6	RT Line Out
7	Front Sense	7	Reserved
8	Key	8	Key
9	Left line in	9	LFT Line Out
10	Jack Sense	10	LFT Line Out

### Note

- » It is recommended that you connect a high-definition front panel audio module to this connector to avail of the motherboard's high definition audio capability.
- » Please try to disable the "Front Panel Jack Detection" if you want to use an AC'97 front audio output cable. The function can be found via O.S. Audio Utility.

## COM: Serial Port Header

The motherboard has a serial port header for connecting RS-232 Port.

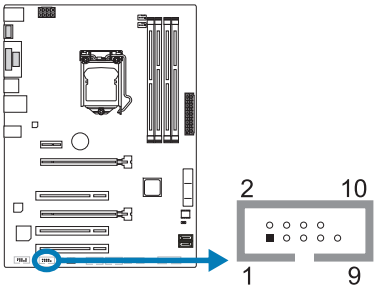

Pin	Assignment
1	Carrier detect
2	Received data
3	Transmitted data
4	Data terminal ready
5	Signal ground
6	Data set ready
7	Request to send
8	Clear to send
9	Ring indicator
10	Key

## Chapter 3: UEFI BIOS & Software

### 3.1 UEFI BIOS Setup

- The BIOS Setup program can be used to view and change the BIOS settings for the computer. The BIOS Setup program is accessed by pressing the <DEL> key after the Power-On Self-Test (POST) memory test begins and before the operating system boot begins.
- For further information of setting up the UEFI BIOS, please refer to the UEFI BIOS Manual on our website.

### 3.2 BIOS Update

The BIOS can be updated using either of the following utilities:

- BIOSSTAR BIOS Flasher: Using this utility, the BIOS can be updated from a file on a hard disk, a USB drive (a flash drive or a USB hard drive), or a CD-ROM.
- BIOSSTAR BIOS Update Utility: It enables automated updating while in the Windows environment. Using this utility, the BIOS can be updated from a file on a hard disk, a USB drive (a flash drive or a USB hard drive), or a CD-ROM, or from the file location on the Web.

#### **BIOSSTAR BIOS Flasher**

##### **Note**

- » This utility only allows storage device with FAT32/16 format and single partition.
- » Shutting down or resetting the system while updating the BIOS will lead to system boot failure.

Updating BIOS with BIOSSTAR BIOS Flasher

1. Go to the website to download the latest BIOS file for the motherboard.
2. Then, copy and save the BIOS file into a USB flash (pen) drive.
3. Insert the USB pen drive that contains the BIOS file to the USB port.
4. Power on or reset the computer and then press <F12> during the POST process.

5. After entering the POST screen, the BIOS-FLASHER utility pops out. Choose <fs0> to search for the BIOS file.



6. Select the proper BIOS file, and a message asking if you are sure to flash the BIOS file. Click “Yes” to start updating BIOS.



7. A dialog pops out after BIOS flash is completed, asking you to restart the system. Press the <Y> key to restart system.

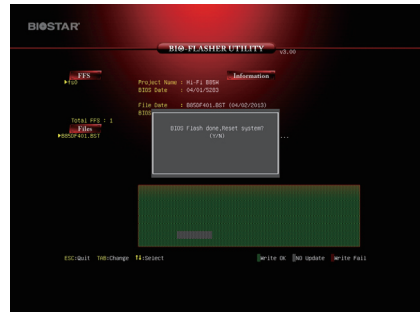

8. While the system boots up and the full screen logo shows up, press <DEL> key to enter BIOS setup.

After entering the BIOS setup, please go to the <Save & Exit>, using the <Restore Defaults> function to load Optimized Defaults, and select <Save Changes and Reset> to restart the computer. Then the BIOS Update is completed.

### **BIOS Update Utility (through the Internet)**

1. Installing BIOS Update Utility from the DVD Driver.
2. Please make sure the system is connected to the internet before using this function.

3. Launch BIOS Update Utility and click the “Online Update” button on the main screen.



4. An open dialog will show up to request your agreement to start the BIOS update. Click “Yes” to start the online update procedure.

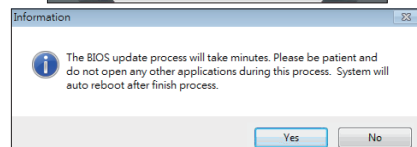

5. If there is a new BIOS version, the utility will ask you to download it. Click “Yes” to proceed.

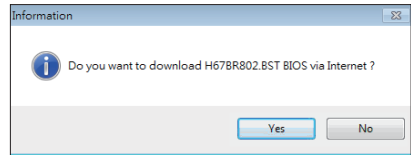

6. After the download is completed, you will be asked to program (update) the BIOS or not. Click “Yes” to proceed.

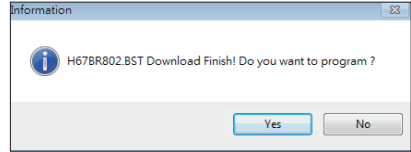

7. After the updating process is finished, you will be asked you to reboot the system. Click “OK” to reboot.

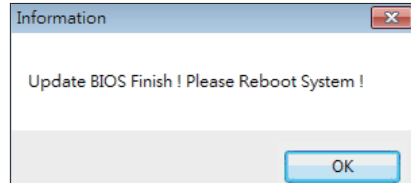

8. While the system boots up and the full screen logo shows up, press <DEL> key to enter BIOS setup.

After entering the BIOS setup, please go to the <Save & Exit>, using the <Restore Defaults> function to load Optimized Defaults, and select <Save Changes> and <Reset> to restart the computer. Then, the BIOS Update is completed.

### **BIOS Update Utility (through a BIOS file)**

1. Installing BIOS Update Utility from the DVD Driver.
2. Download the proper BIOS from <http://www.biostar.com.tw/>

3. Launch BIOS Update Utility and click the “Update BIOS” button on the main screen.



4. A warning message will show up to request your agreement to start the BIOS update. Click “OK” to start the update procedure.

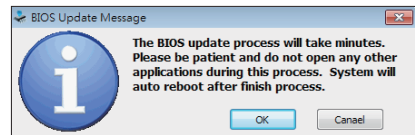

5. Choose the location for your BIOS file in the system. Please select the proper BIOS file, and then click on “Open”. It will take several minutes, please be patient.

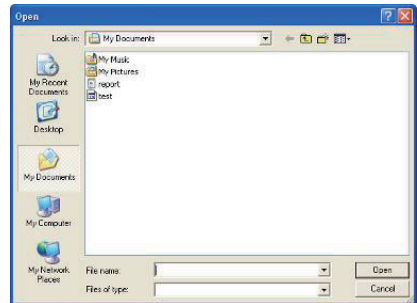

6. After the BIOS Update process is finished, click on “OK” to reboot the system.

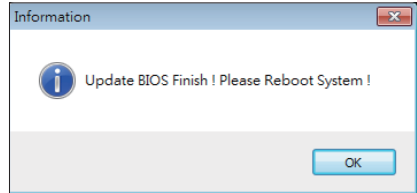

7. While the system boots up and the full screen logo shows up, press <DEL> key to enter BIOS setup.

After entering the BIOS setup, please go to the <Save & Exit>, using the <Restore Defaults> function to load Optimized Defaults, and select <Save Changes and Reset> to restart the computer. Then, the BIOS Update is completed.

### **Backup BIOS**

Click the Backup BIOS button on the main screen for the backup of BIOS, and select a proper location for your backup BIOS file in the system, and click “Save”.

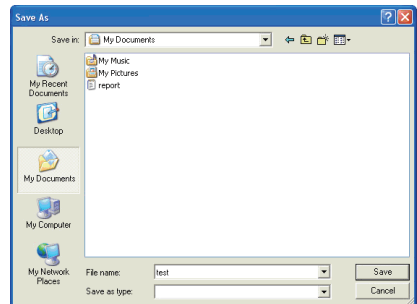

### 3.3 Software

#### Installing Software

1. Insert the Setup DVD to the optical drive. The driver installation program would appear if the Auto-run function has been enabled.
2. Select Software Installation, and then click on the respective software title.
3. Follow the on-screen instructions to complete the installation.

#### Launching Software

After the installation process is completed, you will see the software icon showing on the desktop. Double-click the icon to launch it.

#### Note

- » All the information and content about following software are subject to be changed without notice. For better performance, the software is being continuously updated.
- » The information and pictures described below are for your reference only. The actual information and settings on board may be slightly different from this manual.

#### BIOScreen Utility

This utility allows you to personalize your boot logo easily. You can choose BMP as your boot logo so as to customize your computer.



Please follow the step-by-step instructions below to update boot logo:

- Load Image: Choose the picture as the boot logo.
- Transform: Transform the picture for BIOS and preview the result.
- Update Bios: Write the picture to BIOS Memory to complete the update.

## Charger Booster II

Biostar Charger Booster II technology boosts the charging time of your USB-powered devices. After installing Charger Booster II, the program will appear in the Windows notification area. Right-click the program icon to select CDP (Charging Downstream Port) or DCP (Dedicated Charging Port) charging mode for your USB-powered devices.

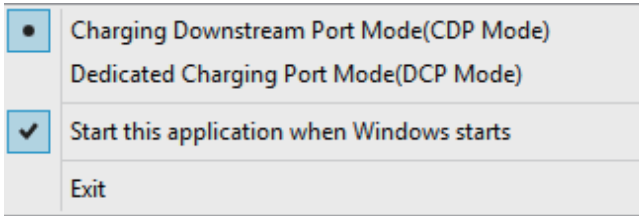

### Note

» Please refer to APPENDIX II for USB-powered device compatible list.

## eHot-Line

eHot-Line is a convenient utility that helps you to contact with our Tech-Support system. This utility will collect the system information which is useful for analyzing the problem you may have encountered, and then send these information to our tech-support department to help you fix the problem.

\* represents important information that you must provide. Without this information, you may not be able to send out the mail.

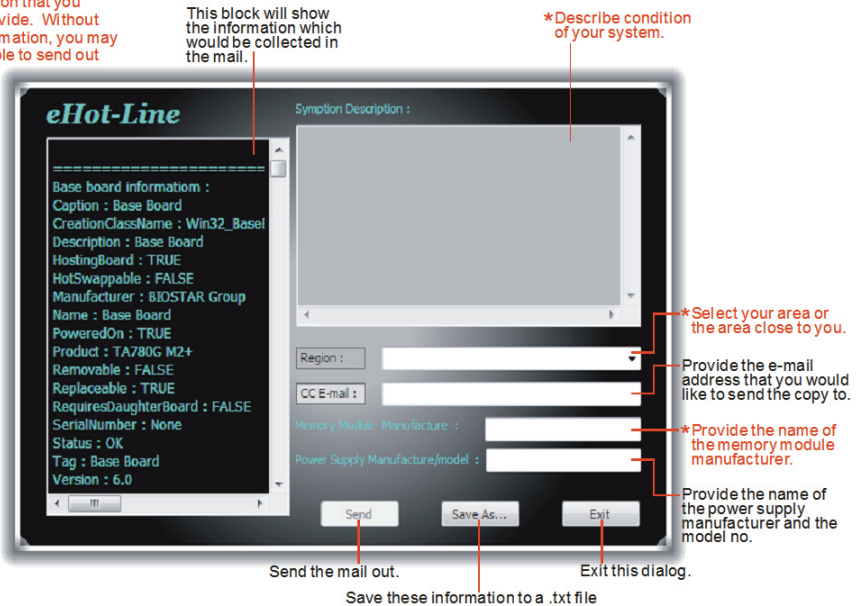





### Green Power II Utility

BIOSTAR G.P.U II (Green Power Utility) is a new function. The utility enhances energy efficiency by disabling extra phases while CPU is on light loading; it features 4+1 power phases, current power saving, and total power saving. This tool integrates a friendly GUI to monitor your CPU Usage, CPU Watt, and CPU Temperature. Moreover, it optimizes power saving and best power efficiency on your system. (The illustration below is for reference only)

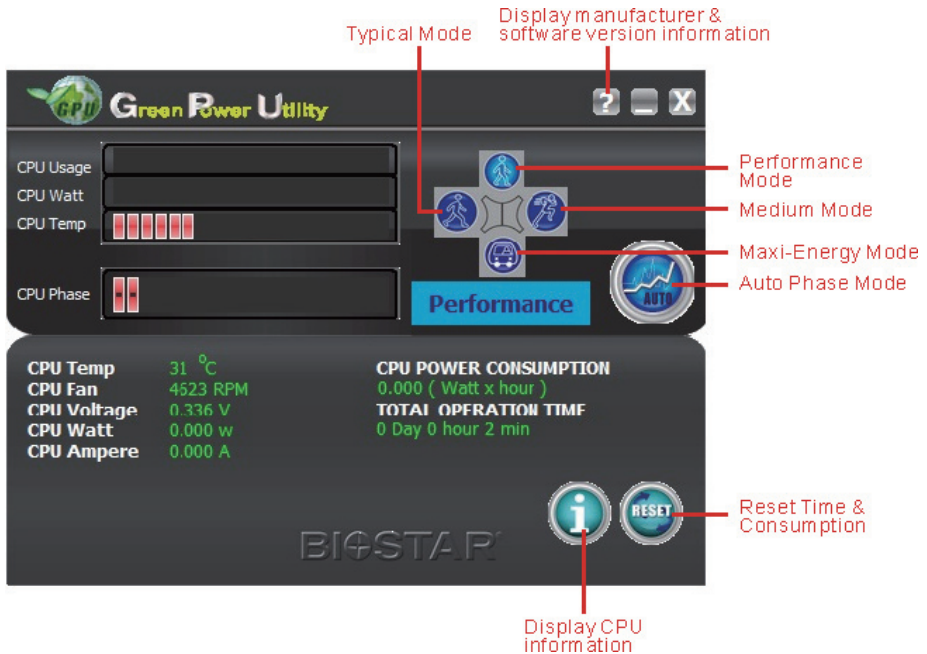

### G.P.U Mode Setting:

This utility provides five modes, upon your requirements, to improve system performance or to save power consumption.

#### Note

» Even if the modes saving more power consumption are chosen, the system still can keep excellent performance.

- Auto Phase Mode: System switches the mode automatically according to current system loading condition.
- Performance Mode: This is the mode saving power consumption most. Least energy will be used in the system.
- Typical Mode: Compared with that in Performance Mode, energy consumption in this mode is a little bit more.
- Medium Mode: The standard system power saving mode.
- Maxi-Energy Mode: The best system performance mode.

## Smart EAR

### Hi-Fi Audio Requirements:

1. An earphone or a headphone
2. A chassis with front audio output jacks, or you can connect the earphone directly to audio line-out port of rear I/Os.
3. Windows 7/ 8.1(64bit)/ 10(64bit) operation system

### Installation Guide:

1. Make sure the front audio cable of the chassis connected to the front audio header of the motherboard properly.
2. Install the Smart Ear Utility from the driver DVD.
3. Connect the earphone to the front audio jack of the chassis or audio line-out port of rear I/Os.

#### Note

» If you want to use an AC'97 front audio output cable, please disable the "Front Panel Jack Detection" setting. This setting can be found via O.S. Audio Utility.

### Smart EAR Utility:



- High/Low Gain Switch: Keep the gain switch to low for low impedance headphone and set to high for high impedance headphone.
- Mute Button: To disable system sound
- Volume Control Knob: The volume can be finely adjusted by turning the knob either clockwise or anti-clockwise to increase or decrease system volume accordingly.
- Information Button: Get information of the application
- Minimize Button: Minimize the application window to the taskbar
- Exit Button: Exit the application

## Chapter 4: Useful help

### 4.1 Driver Installation

After you installed your operating system, please insert the Fully Setup Driver DVD into your optical drive and install the driver for better system performance.

You will see the following window after you insert the DVD



The setup guide will auto detect your motherboard and operating system.

#### **A. Driver Installation**

To install the driver, please click on the Driver icon. The setup guide will list the compatible driver for your motherboard and operating system. Click on each device driver to launch the installation program.

#### **B. Software Installation**

To install the software, please click on the Software icon. The setup guide will list the software available for your system, click on each software title to launch the installation program.

#### **C. Manual**

Aside from the paperback manual, we also provide manual in the Driver DVD. Click on the Manual icon to browse for available manual.

#### **Note**

- » *If this window didn't show up after you insert the Driver DVD, please use file browser to locate and execute the file SETUP.EXE under your optical drive.*
- » *You will need Acrobat Reader to open the manual file. Please download the latest version of Acrobat Reader software from <http://get.adobe.com/reader/>*

## 4.2 AMI BIOS Beep Code

### Boot Block Beep Codes

Number of Beeps	Description
Continuing	Memory sizing error or Memory module not found

### POST BIOS Beep Codes

Number of Beeps	Description
1	Success booting.
8	Display memory error (system video adapter)

## 4.3 AMI BIOS post code

Code	Description
10	PEI Core is started
11	Pre-memory CPU initialization is started
15	Pre-memory North Bridge initialization is started
19	Pre-memory South Bridge initialization is started
2B	Memory initialization. Serial Presence Detect (SPD) data reading
2C	Memory initialization. Memory presence detection
2D	Memory initialization. Programming memory timing information
2E	Memory initialization. Configuring memory
2F	Memory initialization (other).
31	Memory Installed
32	CPU post-memory initialization is started
33	CPU post-memory initialization. Cache initialization
34	CPU post-memory initialization. Application Processor(s) (AP) initialization
35	CPU post-memory initialization. Boot Strap Processor (BSP) selection
36	CPU post-memory initialization. System Management Mode (SMM) initialization
37	Post-Memory North Bridge initialization is started
3B	Post-Memory North Bridge initialization (North Bridge module specific)
4F	DXE IPL is started
60	DXE Core is started
F0	Recovery condition triggered by firmware (Auto recovery)
F1	Recovery condition triggered by user (Forced recovery)
F2	Recovery process started
F3	Recovery firmware image is found
F4	Recovery firmware image is loaded
E0	S3 Resume is started (S3 Resume PPI is called by the DXE IPL)
E1	S3 Boot Script execution
E2	Video repost
E3	OS S3 wake vector call
60	DXE Core is started
61	NVRAM initialization
62	Installation of the South Bridge Runtime Services
63	CPU DXE initialization is started
68	PCI host bridge initialization
69	North Bridge DXE initialization is started
6A	North Bridge DXE SMM initialization is started

Code	Description
70	South Bridge DXE initialization is started
71	South Bridge DXE SMM initialization is started
72	South Bridge devices initialization
78	South Bridge DXE Initialization (South Bridge module specific)
79	ACPI module initialization
90	Boot Device Selection (BDS) phase is started
91	Driver connecting is started
92	PCI Bus initialization is started
93	PCI Bus Hot Plug Controller Initialization
94	PCI Bus Enumeration
95	PCI Bus Request Resources
96	PCI Bus Assign Resources
97	Console Output devices connect
98	Console input devices connect
99	Super IO Initialization
9A	USB initialization is started
9B	USB Reset
9C	USB Detect
9D	USB Enable
A0	IDE initialization is started
A1	IDE Reset
A2	IDE Detect
A3	IDE Enable
A4	SCSI initialization is started
A5	SCSI Reset
A6	SCSI Detect
A7	SCSI Enable
A8	Setup Verifying Password
A9	Start of Setup
AB	Setup Input Wait
AD	Ready To Boot event
AE	Legacy Boot event
AF	Exit Boot Services event
B0	Runtime Set Virtual Address MAP Begin
B1	Runtime Set Virtual Address MAP End
B2	Legacy Option ROM Initialization
B3	System Reset
B4	USB hot plug
B5	PCI bus hot plug
B6	Clean-up of NVRAM
B7	Configuration Reset (reset of NVRAM settings)

## 4.4 Troubleshooting

Probable	Solution
<ol style="list-style-type: none"> <li>1. There is no power in the system. Power LED does not shine; the fan of the power supply does not work.</li> <li>2. Indicator light on keyboard does not shine.</li> </ol>	<ol style="list-style-type: none"> <li>1. Make sure power cable is securely plugged in.</li> <li>2. Replace cable.</li> <li>3. Contact technical support.</li> </ol>
System is inoperative. Keyboard lights are on, power indicator lights are lit, and hard drives are running.	Using even pressure on both ends of the DIMM, press down firmly until the module snaps into place.
System does not boot from a hard disk drive, but can be booted from optical drive.	<ol style="list-style-type: none"> <li>1. Check cable running from disk to disk controller board. Make sure both ends are securely plugged in; check the drive type in the standard CMOS setup.</li> <li>2. Backing up the hard drive is extremely important. All hard disks are capable of breaking down at any time.</li> </ol>
System only boots from an optical drive. Hard disks can be read, applications can be used, but system fails to boot from a hard disk.	<ol style="list-style-type: none"> <li>1. Back up data and applications files.</li> <li>2. Reformat the hard drive. Re-install applications and data using backup disks.</li> </ol>
Screen message shows "Invalid Configuration" or "CMOS Failure."	Review system's equipment. Make sure correct information is in setup.
System cannot boot after user installs a second hard drive.	<ol style="list-style-type: none"> <li>1. Set master/slave jumpers correctly.</li> <li>2. Run SETUP program and select correct drive types. Call the drive manufacturers for compatibility with other drives.</li> </ol>

### **CPU Overheated**

If the system shutdown automatically after power on system for seconds, that means the CPU protection function has been activated.

When the CPU is over heated, the motherboard will shutdown automatically to avoid a damage of the CPU, and the system may not power on again.

In this case, please double check:

1. The CPU cooler surface is placed evenly with the CPU surface.
2. CPU fan is rotated normally.
3. CPU fan speed is fulfilling with the CPU speed.

After confirmed, please follow steps below to relief the CPU protection function.

1. Remove the power cord from power supply for seconds.
2. Wait for seconds.
3. Plug in the power cord and boot up the system.

Or you can:

1. Clear the CMOS data. (See "Close CMOS Header: JCMOS1" section)
2. Wait for seconds.
3. Power on the system again.

## 4.5 RAID Functions

### RAID Definitions

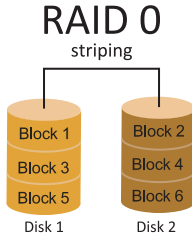

In a RAID 0 system data are split up in blocks that get written across all the drives in the array. By using multiple disks (at least 2) at the same time, this offers superior I/O performance. This performance can be enhanced further by using multiple controllers, ideally one controller per disk.

### Features and Benefits

- Drives: Minimum 2, and maximum is up to 6 or 8. Depending on the platform.
- Uses: Intended for non-critical data requiring high data throughput, or any environment that does not require fault tolerance.
- Benefits: provides increased data throughput, especially for large files. No capacity loss penalty for parity.
- Drawbacks: Does not deliver any fault tolerance. If any drive in the array fails, all data is lost.
- Fault Tolerance: No.
- Total Capacity: (Minimal. HDD Capacity) x (Connected HDDs Amount)

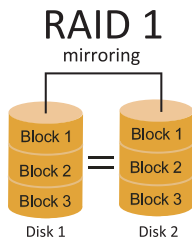

Data are stored twice by writing them to both the data disk (or set of data disks) and a mirror disk (or set of disks) . If a disk fails, the controller uses either the data drive or the mirror drive for data recovery and continues operation. You need at least 2 disks for a RAID 1 array.

### Features and Benefits

- Drives: Minimum 2, and maximum is 2.
- Uses: RAID 1 is ideal for small databases or any other application that requires fault tolerance and minimal capacity.
- Benefits: Provides 100% data redundancy. Should one drive fail, the controller switches to the other drive.
- Drawbacks: Requires 2 drives for the storage space of one drive. Performance is impaired during drive rebuilds.
- Fault Tolerance: Yes.

## RAID 10 (1+0)

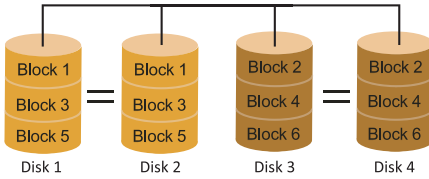

RAID 10 combines the advantages (and disadvantages) of RAID 0 and RAID 1 in one single system. It provides security by mirroring all data on a secondary set of disks (disk 3 and 4 in the drawing below) while using striping across each set of disks to speed up data transfers.

### Features and Benefits

- Drives: Minimum 4, and maximum is 6 or 8, depending on the platform.
- Benefits: Optimizes for both fault tolerance and performance, allowing for automatic redundancy. May be simultaneously used with other RAID levels in an array, and allows for spare disks.
- Drawbacks: Requires twice the available disk space for data redundancy, the same as RAID level 1.
- Fault Tolerance: Yes.

## RAID 5

parity across disks

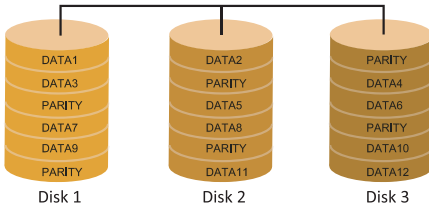

A RAID 5 array can withstand a single disk failure without losing data or access to data. Although RAID 5 can be achieved in software, a hardware controller is recommended. Often extra cache memory is used on these controllers to improve the write performance.

### Features and Benefits

- Drives: Minimum 3.
- Uses: RAID 5 is recommended for transaction processing and general purpose service.
- Benefits: An ideal combination of good performance, good fault tolerance, and high capacity and storage efficiency.
- Drawbacks: Individual block data transfer rate same as a single disk. Write performance can be CPU intensive.
- Fault Tolerance: Yes.

### Note

» For more details settings about Intel® Rapid Storage Technology (Intel® RST), please visit [http://www.intel.com/p/en\\_US/support/highlights/chpsts/imsm](http://www.intel.com/p/en_US/support/highlights/chpsts/imsm)



## APPENDIX I: Specifications in Other Languages

## Arabic

المواصفات	
المأخذ 1151 لمعالج ايه إم دي Intel® Core i7 / i5 / i3 / Pentium / Celeron الحد الأقصى للطاقة الحرارية في تصميم المعالج (thermal design power – TDP): 95 واط. * يرجى الرجوع إلى الموقع <a href="http://www.biostar.com.tw">www.biostar.com.tw</a> لقائمة دعم المعالج CPU.	قاعدة وحدة المعالجة المركزية
INTEL® Z170 (Hi-Fi Z170Z5) INTEL® B150 (Hi-Fi B150Z5)	مجموعة الشرائح
تدعم قناة مزدوجة دي. دي. ار. 1333/1600 DDR3L 2x دي. دي. ار. DDR3L فتحات الذاكرة المزدوجة DIMM، تتحمل كحد أقصى 16 جيجابايت ذاكرة تدعم قناة مزدوجة دي. دي. ار. 1866/2133 DDR4 2x دي. دي. ار. DDR4 فتحات الذاكرة المزدوجة DIMM، تتحمل كحد أقصى 32 جيجابايت ذاكرة * يرجى الرجوع إلى الموقع <a href="http://www.biostar.com.tw">www.biostar.com.tw</a> لقائمة دعم الذاكرة.	الذاكرة
INTEL® Z170: وصلة 1x ساتا SATA Express (16Gb/s) وصلة 4x ساتا SATA III تتحمل رايد RAID 10 / 5 / 1 / 0 AHCI, INTEL® B150: وصلة 1x ساتا SATA Express (16Gb/s) وصلة 4x ساتا SATA III تتحمل رايد AHCI.	التخزين
Intel I219V 1000 / 100 / 10x 1 ميجابايت / الثانية ، تحديد تلقائي ، النصف / القدرة القصوى المزدوجة	شبكة محلية LAN
ALC892 7.1 قنوات عالية البقة، (Front+Rear) Biostar Hi-Fi	التعزيز الصوتي
منافذ 6 x ناقل متسلسل عام USB 3.0 (4 في المداخل والمخارج الخلفية و 2 من خلال الموزع الداخلي) منافذ 6 x ناقل متسلسل عام USB 2.0 (2 في المداخل والمخارج الخلفية و 4 من خلال الموزع الداخلي)	ناقل متسلسل عام USB
3 x فتحة منفذ الملحقات الإضافية PCI 1 x فتحة منفذ الملحقات الإضافية PCI 3.0 x 1 1 x فتحة منفذ الملحقات الإضافية PCI 16 x (x4) 1 x فتحة منفذ الملحقات الإضافية PCI 16 x 3.0 (x16)	فتحات التوسع
1 x PS/2 لوحة المفاتيح للكمبيوتر/الفايرة فتحة توصيل عدد 1 واجهة مرئية رقمية DVI-D فتحة توصيل عدد 1 واجهة مرئية رقمية VGA فتحة توصيل عدد 1 HDMI وسيط متعدد العالي الوضوح فتحة لتوصيل عدد 1 الشبكة المحلية LAN فتحة توصيل عدد 2 ناقل متسلسل عام USB 2.0 فتحة توصيل عدد 4 ناقل متسلسل عام USB 3.0 فتحة توصيل عدد 3 جاك للصوت	المداخل والمخارج الخلفية
وصلة 1x ساتا SATA Express وصلة 4x ساتا SATA III موزع 2 x ناقل متسلسل عام USB 2.0 (كل موزع يتحمل فتحتين ناقل متسلسل عام USB 2.0) موزع 1 x ناقل متسلسل عام USB 3.0 (كل موزع يتحمل فتحتين ناقل متسلسل عام USB 3.0) وصلة للطاقة 1 x 8 دبابيس وصلة للطاقة 1 x 24 دبوس وصلة 1 x مروحة تبريد وحدة المعالجة المركزية وصلة 2 x مراوح تبريد المنظومة موزع 1 x اللوحة الأمامية موزع 1 x الصوت الأمامي موزع 1 x سيموس مباتر وصلة 1 x خارجية S/PDIF سوني فيليبس الواجهة الرقمية موزع 1 x فتحة تسلسلية	المداخل والمخارج الداخلية
عامل شكل مدد التكنولوجيا المتقدمة ATX، 305x 225 مم	عامل الشكل
ويندوز 7 ويندوز 8.1(64bit)/ ويندوز 10(64bit) بيوستار BIOSTAR تحتفظ بحق إضافة أو إزالة الدعم لأي نظام تشغيل مع أو بدون أنظار.	أنظمة التشغيل المدعومة

## German

Spezifikationen	
CPU-Unterstützung	Anschluss-1151 für Intel® Core i7 / i5 / i3 / Pentium / Celeron Prozessor Maximale CPU TDP (Thermal Design Power): 95 Watt * Bitte konsultieren Sie <a href="http://www.biostar.com.tw">www.biostar.com.tw</a> für CPU-Unterstützungsliste
Chipset	INTEL® Z170 (Hi-Fi Z170Z5) INTEL® B150 (Hi-Fi B150Z5)
Festplattenspeicher	Unterstützt zweikanaliges DDR3L 1600/1333 2x DDR3L DIMM-SpeicherSlot, Max. Unterstützung bis zu 16 GB-Speicher Unterstützt zweikanaliges DDR4 2133/1866 2x DDR4 DIMM-SpeicherSlot, Max. Unterstützung bis zu 32 GB-Speicher * Bitte konsultieren Sie <a href="http://www.biostar.com.tw">www.biostar.com.tw</a> für Speicherunterstützung Liste.
Arbeitsspeicher	INTEL® Z170: 1x SATA Express-Verbindung (16Gb/s) 4x SATA III-Verbindung Unterstützt RAID 0,1,10,5, & AHCI INTEL® B150: 1x SATA Express-Verbindung (16Gb/s) 4x SATA III-Verbindung Unterstützt AHCI
LAN	Intel I219V 1x 10/ 100/ 1000 Mb Auto-Negotiation, Halb- / Voll-Duplex-fähig
Audio-Codec	ALC892 7.1 Kanäle, HD-Audio, Biostar Hi-Fi (Front+Rear)
USB	6x USB 3.0-Port (4 hintere I/Os und 2 via interne Header) 6x USB 2.0-Port (2 hintere I/Os und 4 via interne Header)
Erweiterungsanschlüsse	3x PCI Slot 1x PCIe 3.0 x1-Slot 1x PCIe 3.0 x16-Slot (x4) 1x PCIe 3.0 x16-Slot (x16)
Hintere I/Os	1x PS/2-Keybaord/ Maus 1x DVI-D-Port 1x VGA-Port 1x HDMI-Port 1x LAN-Port 2x USB 2.0-Port 4x USB 3.0-Port 3x Audio Jack
Interne I/Os	1x SATA Express-Verbindung 4x SATA III-Verbindung 2x USB 2.0-Header (jeder Header unterstützt 2 USB 2.0-Ports) 1x USB 3.0-Header (jeder Header unterstützt 2 USB 3.0-Ports) 1x 8-Pin-Stromverbindung 1x 24-Pin-Stromverbindung 1x CPU-Ventilatorverbindung 2x System-Ventilatorverbindung 1x Header für Frontpanel 1x Header für Frontaudio 1x Header für klares CMOS 1x S/PDIF-Auswurfsverbindung 1x Header für Seriellen Anschluss
Formfaktor	ATX Formfaktor, 305 mm x 225 mm
OS-Unterstützung	Windows 7/ 8.1(64bit)/ 10(64bit) Biostar reserves the right to add or remove support for any OS with or without notice.

## Russian

Спецификации	
Поддержка центрального процессора	Сокет 1151 для процессоров Intel® Core i7 / i5 / i3 / Pentium / Celeron Максимальный термопакет центрального процессора (TDP): 95 ватт * Перечень поддержки центрального процессора смотрите на <a href="http://www.biostar.com.tw">www.biostar.com.tw</a> .
Набор микросхем	INTEL® Z170 (Hi-Fi Z170Z5) INTEL® B150 (Hi-Fi B150Z5)
Память	Поддерживает двухканальный DDR3L 1600/1333 2 гнезда платы памяти DDR3L DIMM, максимальная память до 16 Гб Поддерживает двухканальный DDR4 2133/1866 2 гнезда платы памяти DDR4 DIMM, максимальная память до 32 Гб * Перечень поддержки памяти смотрите на <a href="http://www.biostar.com.tw">www.biostar.com.tw</a> .
Накопитель	INTEL® Z170: Соединитель 1x SATA Express (16Gb/s) Соединитель 4x SATA III Поддерживает RAID 0,1,10,5, & AHCI INTEL® B150: Соединитель 1x SATA Express (16Gb/s) Соединитель 4x SATA III Поддерживает AHCI
Локальная сеть	Intel I219V 1x Автосогласование 10/ 100/ 1000 Мб/с, работает в полно/полудуплексном режиме
Аудиокодек	ALC892 Каналы 7.1, высококачественное аудио, Biostar Hi-Fi (Front+Rear)
USB	6 порта USB 3.0 (4 сзади ввода-вывода и 2 через внутренние контакты) 6 порта USB 2.0 (2 сзади ввода-вывода и 4 через внутренние контакты)
Гнезда расшир.	3x PCI гнездо 1x PCIe 3.0 x1 гнездо 1x PCIe 3.0 x16 гнездо (x4) 1x PCIe 3.0 x16 гнездо (x16)
Задняя плата ввода-вывода	1 клавиатура/ мышь PS/2 1 порт DVI-D 1 порта VGA 1 порт HDMI 1 порт локальной сети 2 порта USB 2.0 4 порта USB 3.0 3 гнезд для подключения наушников
Внутр. Плата ввода-вывода	Соединитель 1x SATA Express Соединитель 4x SATA III 2 контакта USB 2.0 (каждый контакт поддерживает 2 порта USB 2.0) 1 контакт USB 3.0 (каждый контакт поддерживает 2 порта USB 3.0) 1 8-выводный разъем питания 1 24-выводный разъем питания 1 разъем вентилятора ЦП 2 разъема вентилятора системы 1 контакт передней панели 1 контакт передней аудиопанели 1 контакт микросхемы Clear CMOS 1 соединитель S/PDIF-Out 1 контакт последовательного порта
Конструктив	Форм-фактор ATX, 305 мм x 225 мм
Поддержка ОС	Windows 7/ 8.1(64bit)/ 10(64bit) Biostar оставляет за собой право добавлять или удалять поддержку любой ОС, с уведомлением или без.

## Spanish

Especificaciones	
Compatibilidad con el procesador	Ranura 1151 para procesador Intel® Core i7 / i5 / i3 / Pentium / Celeron Alimentación de Proyección Térmica (TDP – Thermal Design Power): 95Watt *Por favor consultar con <a href="http://www.biostar.com.tw">www.biostar.com.tw</a> para la lista de compatibilidad con el procesador.
Tipo de Placa	INTEL® Z170 (Hi-Fi Z170Z5) INTEL® B150 (Hi-Fi B150Z5)
Memoria	Soporta DDR3L 1600/1333 Doble Canal 2x DDR3L DIMM Ranura de memoria Soporta hasta 16 GB Memoria Soporta DDR4 2166/1866 Doble Canal 2x DDR4 DIMM Ranura de memoria Soporta hasta 32 GB Memoria *Por favor consultar con <a href="http://www.biostar.com.tw">www.biostar.com.tw</a> para la lista de compatibilidad con el memoria.
Almacenamiento de información	INTEL® Z170: Conector 1x SATA Express (16Gb/s) Conector 4x SATA III Soporta RAID 0,1,10,5, & AHCI INTEL® B150: Conector 1x SATA Express (16Gb/s) Conector 4x SATA III Soporta AHCI
LAN	Intel I219V 1x 10/ 100/ 1000 Mb/s auto negociación, capacidad dúplex Mitad/Completo
Códec Audio	ALC892 Canales Audio de Alta Definición 7.1, Biostar Hi-Fi (Front+Rear)
USB	Ranura 6x USB 3.0 (4 en las entrada/salidas posteriores y 2 por los distribuidores internos) Ranura 6x USB 2.0 (2 en las entrada/salidas posteriores y 4 por los distribuidores internos)
Ranuras de Extinción	Ranura 3x PCI Ranura 1x PCIe 3.0 x1 Ranura 1x PCIe 3.0 x16 (x4) Ranura 1x PCIe 3.0 x16 (x16)
Panel trasero de E/S	Teclado/ Ratón 1x PS/2 Ranura 1x DVI-D Ranura 1x VGA Ranura 1x HDMI Ranura 1x LAN Ranura 2x USB 2.0 Ranura 4x USB 3.0 Socket audio 3x
Conectores en placa	Conector 1x SATA Express Conector 4x SATA III Distribuidor 2x USB 2.0 (cada distribuidor soporta 2 ranuras USB 2.0) Distribuidor 1x USB 3.0 (cada distribuidor soporta 2 ranuras USB 3.0) Conector con 8 patillas x1 Conector con 24 patillas x1 Conector Ventilador procesador x1 Conector Ventilador Sistema x2 Distribuidor Panel Frontal x1 Distribuidor Audio Frontal x1 Distribuidor CMOS Directo x1 Conector Externo S/PDIF x1 Distribuidor Ranura Serie x1
Factor de Forma	Factor de Forma ATX, 305 mm x 225 mm
Soporte OS	Windows 7/ 8.1(64bit)/ 10(64bit) Biostar reserva su derecho de añadir o retirar el soporte para cada OS con o sin notificación.

## Thai

คุณสมบัติ	
ซีพียู	ซ็อกเก็ต 1151 สำหรับโปรเซสเซอร์ Intel Core i7 / i5 / i3 / Pentium / Celeron CPU TDP (Thermal Design Power) สูงสุด: 95Watt * เข้าชมได้ที่ <a href="http://www.biostar.com.tw">www.biostar.com.tw</a> สำหรับรายการซีพียูที่สนับสนุน
ชิพเซ็ต	INTEL® Z170 (Hi-Fi Z170Z5) INTEL® B150 (Hi-Fi B150Z5)
หน่วยความจำ	สนับสนุน Dual Channel DDR3L 1600/1333 รองรับหน่วยความจำ 2 สล็อต DDR3L DIMM สูงสุดถึง 16 GB สนับสนุน Dual Channel DDR4 2133/1866 รองรับหน่วยความจำ 2 สล็อต DDR4 DIMM สูงสุดถึง 32 GB * เข้าชมได้ที่ <a href="http://www.biostar.com.tw">www.biostar.com.tw</a> สำหรับรายการหน่วยความจำที่สนับสนุน
กราฟฟิก	รวมกราฟฟิกอยู่ในซีพียู
สต่อเรจ	INTEL® Z170: 1x SATA Express พอร์ตเชื่อมต่อ (16Gb/s) 4x SATA III พอร์ตเชื่อมต่อ สนับสนุน RAID 0,1,5,10, AHCI INTEL® B150: 1x SATA Express พอร์ตเชื่อมต่อ (16Gb/s) 4x SATA III พอร์ตเชื่อมต่อ สนับสนุน AHCI
แลน	Intel I219V 1x 10/ 100/ 1000 Mb/s การเจรจาอัตโนมัติ, ความสามารถในการพลิกซ์ Half / Full
ออดิโอ โคเดค	ALC892 7.1 Channels, High Definition Audio, Biostar Hi-Fi (Front+Rear)
ยูเอสบี	6x USB 3.0 พอร์ต (4 พอร์ตด้านหลัง I/O และ 2 พอร์ต ผ่านพอร์ตเชื่อมต่อด้านใน) 6x USB 2.0 พอร์ต (2 พอร์ตด้านหลัง I/O และ 4 พอร์ต ผ่านพอร์ตเชื่อมต่อด้านใน)
สล็อตขยายเพิ่มเติม	3x PCI สล็อต 1x PCIe 3.0 x1 สล็อต 1x PCIe 3.0 x16 สล็อต (x4) 1x PCIe 3.0 x16 สล็อต (x16)
พอร์ต I/O ด้านหลัง	1x PS/2 เมาส์/ คีย์บอร์ด 1x DVI-D พอร์ต 1x VGA พอร์ต 1x HDMI พอร์ต 1x LAN พอร์ต 2x USB 2.0 พอร์ต 4x USB 3.0 พอร์ต 3x Audio Jack
พอร์ต I/O ด้านใน	1x SATA Express พอร์ตเชื่อมต่อ 4x SATA III พอร์ตเชื่อมต่อ 2x USB 2.0 พอร์ตเชื่อมต่อ (หัวเชื่อมต่อทุกตัวรองรับ 2 พอร์ต USB 2.0) 1x USB 3.0 พอร์ตเชื่อมต่อ (หัวเชื่อมต่อทุกตัวรองรับ 2 พอร์ต USB 3.0) 1x 8-Pin Power พอร์ตเชื่อมต่อ 1x 24-Pin Power พอร์ตเชื่อมต่อ 1x พอร์ตเชื่อมต่อ CPU Fan 2x พอร์ตเชื่อมต่อระบบ Fan 1x พอร์ตเชื่อมต่อแผงด้านหน้า 1x พอร์ตเชื่อมต่อออดิโอด้านหน้า 1x พอร์ต Clear CMOS 1x พอร์ตเชื่อมต่อออก S/PDIF 1x พอร์ตเชื่อมต่อ Serial Port
รูปแบบจากโรงงาน	ขนาด ATX จากโรงงาน, 305 มม. x 225 มม. Windows 7/ 8.1(64bit)/ 10(64bit)
สนับสนุน OS	Biostar ขอสงวนสิทธิ์ในการเพิ่มหรือลดการสนับสนุนสำหรับระบบปฏิบัติการ OS ต่างๆ โดยไม่ต้องแจ้งให้ทราบล่วงหน้า

## APPENDIX II: Charger Boost II Compatible Devices

	<b>KB/Mouse</b>		<b>Mobile Phone</b>		<b>Apple Device</b>		<b>Tablet</b>
<b>1</b>	Acer USB mouse	<b>1</b>	HTC Sensation	<b>1</b>	Apple iPhone6	<b>1</b>	Lenovo Table A1
<b>2</b>	Caibo USB mouse	<b>2</b>	HTC ONEX	<b>2</b>	Apple iPhone5	<b>2</b>	Nexus 7 3G version
<b>3</b>	KINYO USB mouse	<b>3</b>	HTC J	<b>3</b>	Apple iPhone4	<b>3</b>	Nexus 7 2013 wifi version
<b>4</b>	KINYO USB keyboard	<b>4</b>	HTC Desire 600	<b>4</b>	Apple iPhone3GS	<b>4</b>	Samsung note 10.1
<b>5</b>	M5 USB mouse	<b>5</b>	HTC M7	<b>5</b>	Apple iPod 20G		
<b>6</b>	Logitech wireless USB mouse	<b>6</b>	LG G2	<b>6</b>	Apple iPhone 4S		
		<b>7</b>	LG G3	<b>7</b>	Apple iPad		
		<b>8</b>	Lenovo Lephone S2	<b>8</b>	Apple iPad2		
		<b>9</b>	Samsung S2	<b>9</b>	Apple new iPad		
		<b>10</b>	Samsung Note	<b>10</b>	Apple iPad4		
		<b>11</b>	Samsung S3	<b>11</b>	Apple iPad air		
		<b>12</b>	Samsung ACE	<b>12</b>	Apple iPad mini		
		<b>13</b>	Samsung Note3				
		<b>14</b>	Mi 3				
		<b>15</b>	Sony Z				

## FCC条款

依照FCC条款第15部分的规定，本装置已经通过测试并且符合Class B级数字装置的限制。此条款限制了在安装过程中可能造成的有害射频干扰并提供了合理的防范措施。本装置在使用时会产生无线射频辐射，如果没有依照本手册的指示安装和使用，可能会与无线通讯装置产生干扰。然而，并不保证在特定的安装下不会发生任何干扰。

如果关闭和重新开启本设备后，仍确定本装置造成接收广播或电视的干扰，用户可以使用以下列表中的一种或多种方法来减少干扰：

- 重新安装或调整接收天线。
- 增加本设备与接收设备之间的距离。
- 连接设备连接到不同的插座以便于两个设备使用不同的回路。
- 咨询经销商或富有经验的无线电工程师，以获得更多资讯。

本用户手册内容的变更，恕不另行通知，制造商没有解释的义务。

本用户手册的所有内容若有任何错误，制造商没有义务为其承担任何责任。所有商标和产品名称均有其各自所有权。

未经过书面许可，不得以任何形式（部分或全部）复制此手册信息。

## 免责声明

本手册内容系BIOSTAR®知识产权，版权归BIOSTAR®所有。我们本着对用户负责的态度，精心地编写该手册，但不保证本手册的内容完全准确无误。BIOSTAR®有权在不知会用户的前提下对产品不断地进行改良、升级及对手册内容进行修正，实际状况请以产品实物为准。本手册为纯技术文档，无任何暗示及影射第三方之内容，且不承担排版错误导致的用户理解歧义。本手册中所涉及的第三方注册商标所有权归其制造商或品牌所有人。



### CE符合性简短声明

我们声明此产品符合现行标准，并满足2004/108/CE、2006/95/CE 和1999/05/CE指令规定的所有基本要求。

## 防静电操作规则

静电可能严重损坏您的设备，在处理主板以及其它的系统设备的时候要特别注意，避免和主板上的系统组件的不必要接触，保证在抗静电的环境下工作，避免静电放电可能对主板造成损坏，当在您的机箱中插入或者移除设备时，请保证电源处于断开状态，厂商对于不遵照本操作规则或者不遵守安全规范而对主板造成的损坏不负责。



**警告**  
主板易受静电损坏  
请遵守操作规则



# 目录

<b>第一章: 主板介绍 .....</b>	<b>3</b>
1.1 前言 .....	3
1.2 包装清单 .....	3
1.3 主板特性 .....	4
1.4 后置面板接口 .....	5
1.5 主板布局图 .....	6
<b>第二章: 硬件安装 .....</b>	<b>7</b>
2.1 中央处理器(CPU) .....	7
2.2 散热片 .....	9
2.3 风扇接头 .....	10
2.4 系统内存 .....	10
2.5 扩展槽 .....	12
2.6 跳线设置 .....	13
2.7 接口和插槽 .....	14
<b>第三章: UEFI BIOS和软件 .....</b>	<b>18</b>
3.1 UEFI BIOS设置 .....	18
3.2 刷新BIOS .....	18
3.3 软件 .....	22
<b>第四章:帮助信息 .....</b>	<b>27</b>
4.1 驱动程序安装注意事项 .....	27
4.2 AMI BIOS 哔声代码 .....	28
4.3 AMI BIOS 开机自检代码 .....	28
4.4 问题解答 .....	30
4.5 RAID 功能 .....	31
<b>附录I : 产品中有毒有害物质或元素的名称及含量 .....</b>	<b>33</b>
<b>附录II : Charger Boost II 设备兼容列表 .....</b>	<b>34</b>



# 第一章: 主板介绍

## 1.1 前言

感谢您选购我们的产品。在开始安装主板前，请仔细阅读以下安全指导说明：

- 选择清洁稳定的工作环境。
- 操作前请确保计算机断开电源。
- 从防静电袋取出主板之前，先轻触安全触地器或使用触地手腕带去除静电以确保安全。
- 避免触摸主板上的零件。手持电路板的边缘，不要弯曲或按压电路板。
- 安装之后，确认没有任何小零件置于机箱中，一些小的零件可能引起电流短路并可能损坏设备。
- 确保计算机远离危险区域，如：高温、潮湿、靠近水源的地方。
- 计算机的工作温度应保持在0-45°C之间
- 为避免受伤，请注意以下幾點：  
主板或连接器上尖銳的針腳  
机箱上的粗糙边缘和尖角  
破损的线缆可能引起短路

## 1.2 包装清单

- Serial ATA数据线 x2
- ATX机箱后置I/O面板 x1
- 用户手册 x1
- 驱动光盘 x1 (包括安装驱动)

---

### 注意

» 此清单可能因销售区域或主板型号不同而异，相关标配详情请咨询当地经销商。

---

## 1.3 主板特性

规格	
CPU支援	Socket 1151 · Intel Core i7 / i5 / i3 / Pentium / Celeron处理器 CPU最大热功耗(95Watt) * 请访问 <a href="http://www.biostar.com.tw">www.biostar.com.tw</a> 获取CPU的支持列表
芯片组	INTEL® Z170 (Hi-Fi Z170Z5); INTEL® B150 (Hi-Fi B150Z5)
内存	支持双通道DDR3L 1600/1333 2个DDR3L DIMM插槽 · 最大内存容量为16GB 支持双通道DDR4 2133/1866 2个DDR4 DIMM插槽 · 最大内存容量为32GB * 请访问 <a href="http://www.biostar.com.tw">www.biostar.com.tw</a> 获取内存的支持列表 * * 若同时安装DDR3L和DDR4内存模组于主板上 · 则主板可能遭受损坏 ·
存储器	INTEL® Z170: 1个SATA Express接口 (16Gb/s), 4个SATA III 接口 支持RAID 0, 1, 10, 5, & AHCI INTEL® B150: 1个SATA Express接口 (16Gb/s), 4个SATA III 接口 支持 AHCI
网络	Intel I219V, 1x 10/ 100/ 1000 Mb/s自适应传输模式 · 半双工/全双工工作模式
音效	ALC892 8声道音频输出 · 支持高清音频 · Biostar Hi-Fi 3D
USB	6个USB 3.0端口(背板4个端口 · 板载接头支持2个端口) 6个USB 2.0端口(背板2个端口 · 板载接头支持4个端口)
扩展槽	3个PCI 插槽 1个PCIe 3.0 x1插槽 1个PCIe 3.0 x16插槽(x4) 1个PCIe 3.0 x16插槽(x16)
背板接口	1个PS/2键盘/鼠标接口 1个DVI-D端口 1个VGA端口 1个HDMI端口 1个LAN端口 2个USB2.0端口 4个USB3.0端口 3个音频插孔
板载接口	1个SATA Express接口 4个SATA III接口 2个USB2.0接头(每个接头支持2个USB2.0端口) 1个USB3.0接头(每个接头支持2个USB3.0端口) 1个电源接口(8针) 1个电源接口(24针) 1个CPU风扇接头 2个系统风扇接头 1个前置面板接头 1个前置音频接头 1个清空CMOS数据接头 1个S/PDIF输出接头 1个串口接头
主板尺寸	ATX Form Factor, 305 mm x 225 mm
操作系统支持	Windows 7/ 8.1(64bit)/ 10(64bit) * 如有增加或减少任何OS支持 · Biostar保留不预先通知的权利 ·

## 1.4 后置面板接口

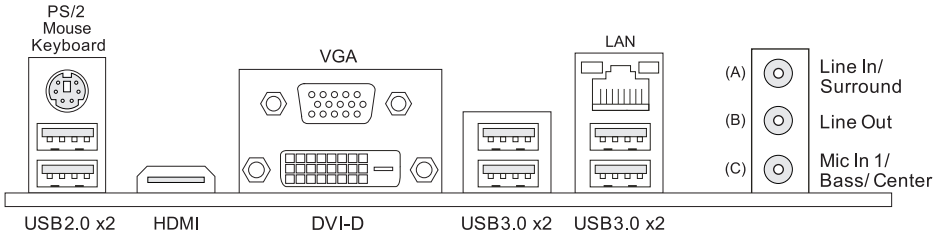

### 注意

- » 仅Intel集成显卡处理器支持VGA、HDMI和DVI-D端口。
- » 最高分辨率：
  - HDMI: 4096 x 2160 @24Hz, 符合HDMI 1.4规范
  - VGA: 1920 x 1200 @60Hz
  - DVI-D: 1920 x 1200 @60Hz
- » 主板同时支持3个板载显示端口输出。显示输出的配置可以在英特尔图形驱动程序工具中进行选择。

## 2/ 4/ 5.1/ 7.1-声道模式配置

音频接口	2 声道模式	4 声道模式	5.1 声道模式	7.1 声道模式
A (背部面板)	线性输入	后置声道输出	后置声道输出	后置声道输出
B (背部面板)	线性输出	前置声道输出	前置声道输出	前置声道输出
C (背部面板)	麦克风输入	麦克风输入	中置/重低单声道输出	中置/重低单声道输出
草绿色 (前置面板)	--	--	--	侧边声道输出

## 1.5 主板布局图

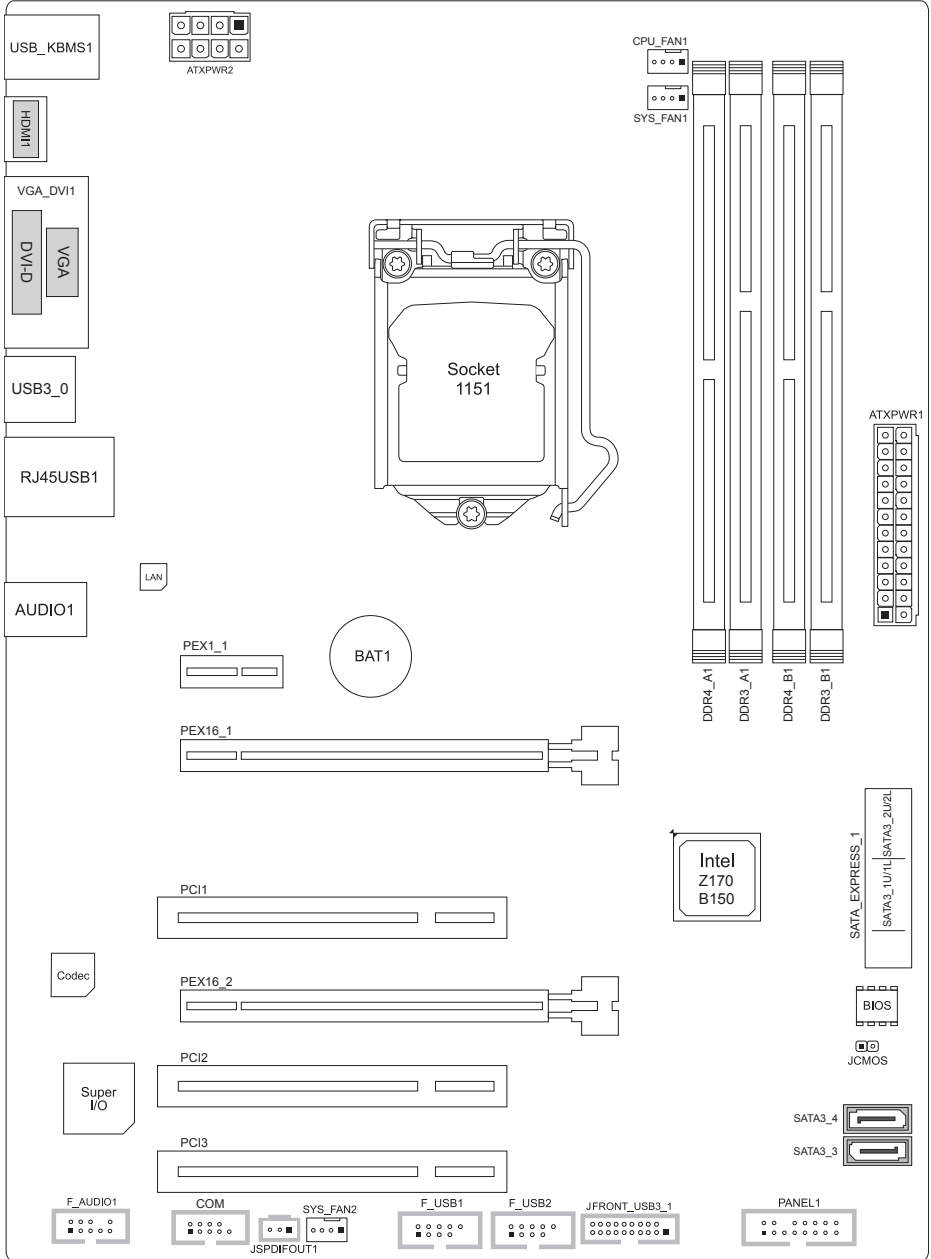

### 注意

» ■ 标示为针脚1

## 第二章: 硬件安装

### 2.1 中央处理器(CPU)

步骤1: 找到主板上的CPU插槽。

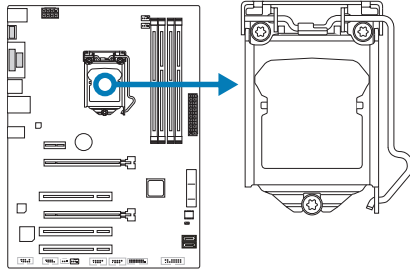

#### 注意

- » 安装前请取掉针脚保护盖，并妥善保管以备后用。移开CPU后，请盖上保护盖以确保针脚不被损坏。
- » 主板可能配有两种不同的针脚保护盖，请参照以下指示取掉保护盖。

步骤2: 将拉杆从插槽移出并向上抬起

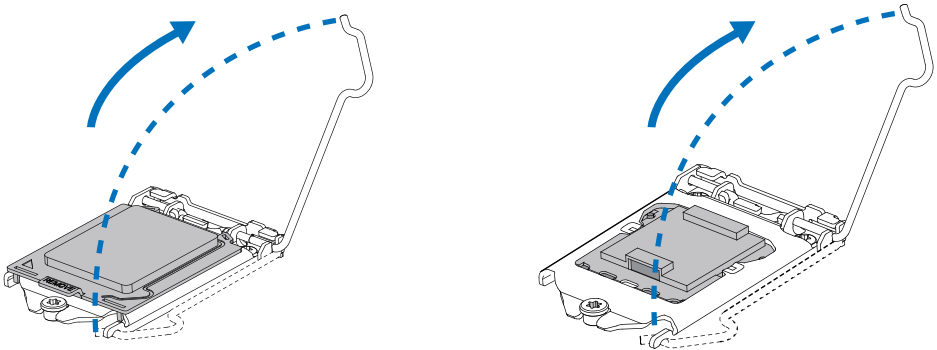

步骤3: 取掉针脚保护盖

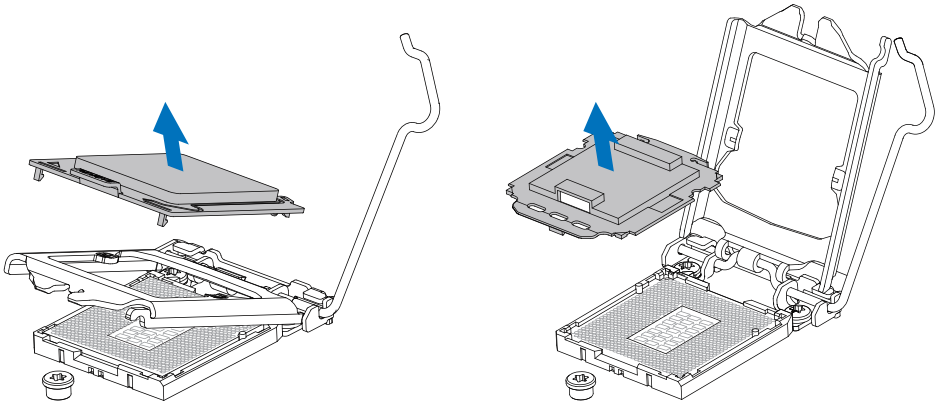

步骤4: 按照箭头的指示方向，将CPU上的切口对准插槽上相应的位置，然后将CPU放入插槽处

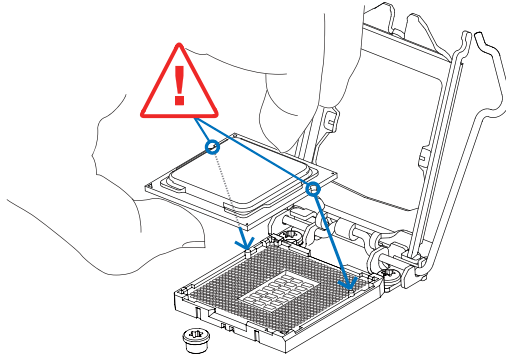

步骤5: 固定CPU，将拉杆闭合。

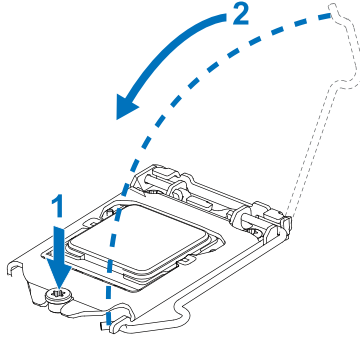

**注意**

- » 请确保安装专为LGA1151插座设计的CPU。
- » CPU必须按正确的方向放入，不要强行将CPU放进插槽以免损坏CPU。

## 2.2 散热片

步骤1: 请将CPU风扇组件置于CPU顶部，确保四个钉钩对齐主板上的插孔，调整其方位，使风扇电线与CPU风扇接口间距最近。确保钉钩插槽垂直指向散热片。

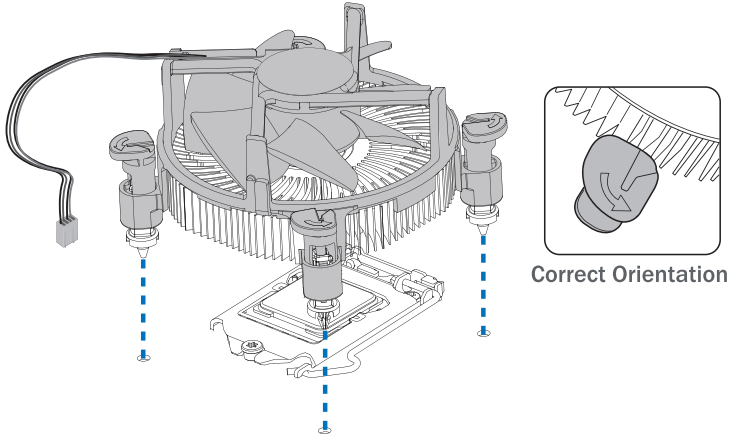

步骤2: 依次把对角2个钉钩同时向下按，以固定风扇，完成CPU安装。

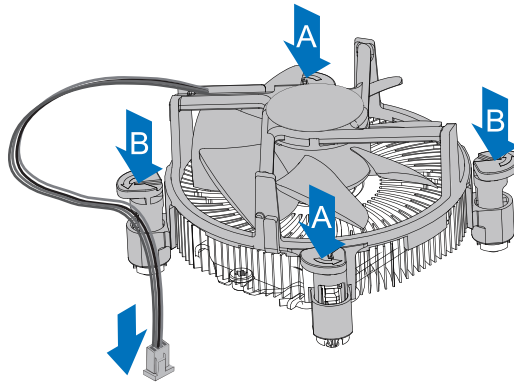

### 注意

- » 如有必要，在安装散热风扇前请先涂抹散热膏于CPU表面。
- » 请务必连接CPU风扇接口。
- » 请参照CPU散热片的安装手册获取正确的安装信息。

## 2.3 风扇接头

此风扇接头支持电脑内置的冷却风扇，风扇引线和插头可能因制造商而异。

### CPU\_FAN1: CPU 风扇接头

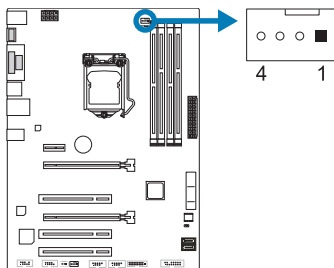

Pin	Assignment
1	接地
2	+12V
3	FAN RPM rate sense
4	Smart Fan Control (By Fan)

### SYS\_FAN1/2: 系统风扇接头

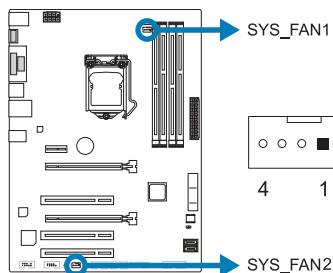

Pin	Assignment
1	接地
2	+12V
3	FAN RPM rate sense
4	Smart Fan Control (By Fan)

#### 注意

- » CPU\_FAN1·SYS\_FAN1/2支持4针脚和3针脚接口；接线时请注意红线是正极需接到第二个针脚，黑线接地需接到GND针脚。

## 2.4 系统内存

### DDR3L/DDR4内存模组

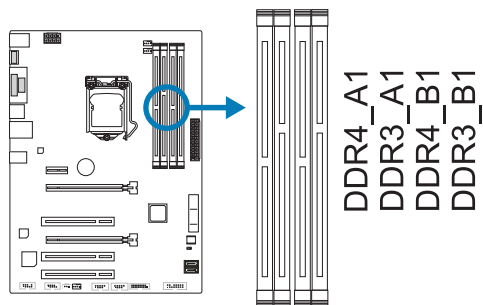



步骤1: 向外推开固定夹，打开DIMM插槽。将DIMM按顺序放在插槽上，DIMM上的切口须与插槽凹口匹配。

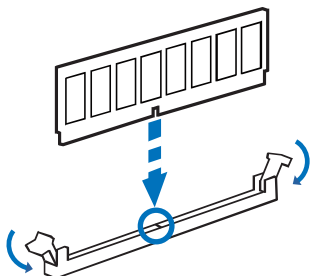

步骤2: 垂直插入DIMM并固定好，直到固定夹跳回原位，DIMM就位。

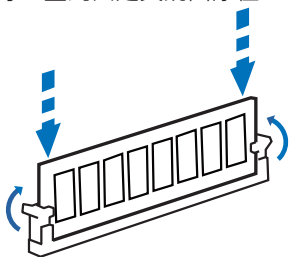

#### 注意

- » 如果DIMM未顺利插入，请勿强行按压。将DIMM拔出，再重插一次。
- » 若同时安装DDR3L和DDR4内存模组于主板上，则主板可能遭受损坏。

## 内存容量

DIMM插槽位置	DDR3L模组	最大内存容量
DDR3_A1	4GB/8GB	16GB
DDR3_B1	4GB/8GB	
DIMM插槽位置	DDR4模组	最大内存容量
DDR4_A1	4GB/8GB/16GB	32GB.
DDR4_B1	4GB/8GB/16GB	

## 双通道内存安装

为激活主板双通道功能，使用内存模组必须符合以下要求：成对安装相同密度的内存模组。如下表所示

双通道状态	DDR3_A1	DDR3_B1	DDR4_A1	DDR4_B1
Enabled	O	O	X	X
Enabled	X	X	O	O

(“O”表示内存已安装，“X”表示内存未安装。)

#### 注意

- » 当安装多个内存模块时，我们建议使用相同品牌和容量的内存于主板上。

## 2.5 扩展槽

### PCI1/ PCI2/ PCI3: 外围设备互联插槽

- PCI插槽支持用于PC的扩展卡包括：网卡·声卡·调制解调器·电视调谐器扩展卡和其他符合PCI标准的扩展卡。

### PEX16\_1: PCI-Express Gen3 x16 插槽

- 符合PCI-Express 3.0规范。
- 同步单向最大理论带宽为16GB/s·总带宽为32GB/s。

### PEX16\_2: PCI-Express Gen3 x4 插槽

- 符合PCI-Express 3.0规范。
- 同步单向最大理论带宽为4GB/s·总带宽为8GB/s。

### PEX1\_1: PCI-Express Gen3 x1 插槽

- 符合PCI-Express 3.0规范。
- 同步单向最大理论带宽为1GB/s·总带宽为2GB/s。

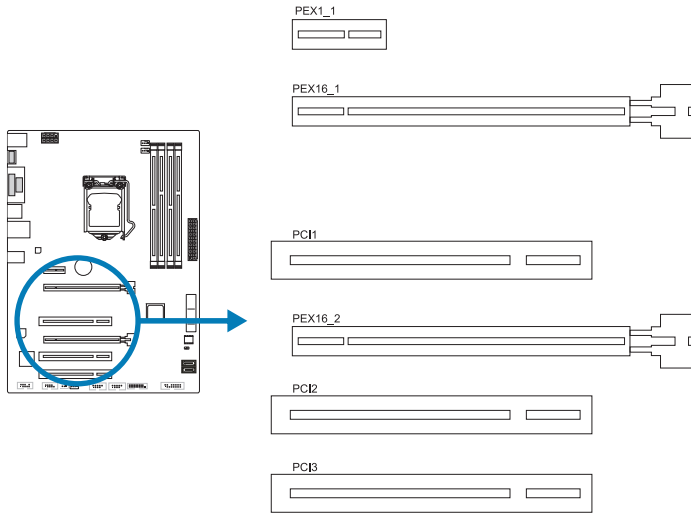

### 安装扩展卡

请参照以下步骤安装扩展卡：

- 安装扩展卡前请阅读扩展卡的相关指示说明。
- 打开电脑机箱后盖，移除螺丝和插槽支架。
- 将扩展卡按照正确的方向插入插槽，直到扩展卡完全就位。
- 用螺丝将扩展卡的金属支架固定到机箱后置面板。
- 还原电脑机箱后盖。
- 开机。如有必要，可为扩展卡更改BIOS设置。
- 安装扩展卡的驱动。

## 2.6 跳线设置

下图展示如何设置跳线。当跳帽放置在针脚上时，跳线为闭合(close)状态。否则跳线为断开(open)状态。

Pin 打开



Pin 闭合



Pin 1-2 闭合

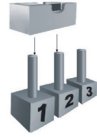

### JCMOS1: 清空CMOS 跳线

用户可清空CMOS数据并恢复BIOS安全设置，请按照以下步骤操作以免损坏主板。

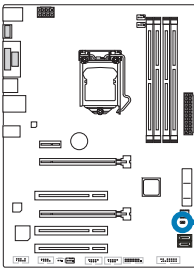

#### 清空CMOS数据过程:

1. 断开AC电源。
2. 将跳线设置成1-2接脚闭合，建议可以使用一个金属物体如螺丝刀触碰1-2接脚。
3. 等待5秒钟。
4. 清空CMOS数据後，请确认跳线设置成1-2接脚打开。
5. 接通AC电源。
6. 开机然后按下<Del>键进入BIOS设置。

## 2.7 接口和插槽

### ATXPWR1: ATX电源接口

为了更好的兼容性，我们建议使用标准的ATX24-pin电源供应此接口的电源。

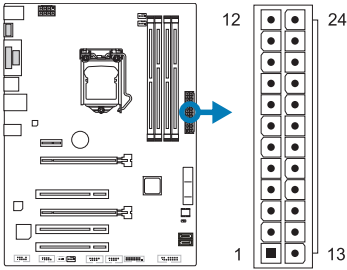

针	定义	针	定义
13	+3.3V	1	+3.3V
14	-12V	2	+3.3V
15	接地	3	接地
16	PS_ON	4	+5V
17	接地	5	接地
18	接地	6	+5V
19	接地	7	接地
20	NC	8	PW_OK
21	+5V	9	唤醒电压+5V
22	+5V	10	+12V
23	+5V	11	+12V
24	接地	12	+3.3V

### ATXPWR2: ATX电源接口

此接口给CPU电路提供+12V电压。若CPU电源插头为4针脚，请将其插入ATXPWR2的1-2-5-6针脚。

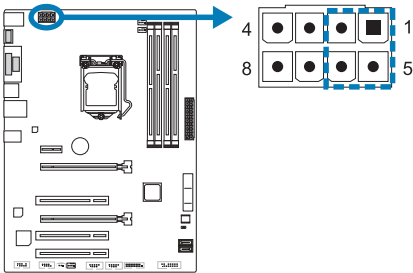

针	定义
1	+12V
2	+12V
3	+12V
4	+12V
5	接地
6	接地
7	接地
8	接地

#### 注意

- » 开机前，请确保ATXPWR1和ATXPWR2接口都已插上电源。
- » 电压不足可能导致系统不稳或者外围设备不能正常运行。当配置使用大功率设备的系统时，建议您使用带有大功率输出的电源。

## PANEL1: 前置面板接头

此16针脚接口包含开机·重启·硬盘指示灯·电源指示灯和扬声器接口。

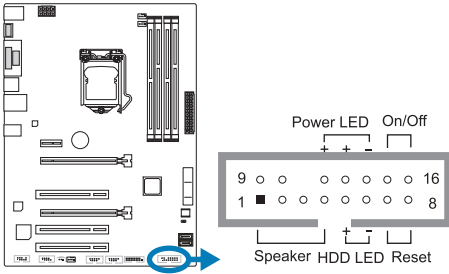

针	定义	功能	针	定义	功能
1	+5V	扬声器接口	9	N/A	N/A
2	N/A		10	N/A	
3	N/A		11	N/A	
4	扬声器	硬盘指示灯	12	Power LED (+)	电源指示灯
5	HDD LED (+)		13	Power LED (+)	
6	HDD LED (-)	重启按钮	14	Power LED (-)	开机按钮
7	接地		15	电源按钮	
8	Reset control	按钮	16	接地	

## SATA\_Express\_1: SATA Express 接口

每个SATA Express接口支持1个SATA Express设备或者2个SATA设备。

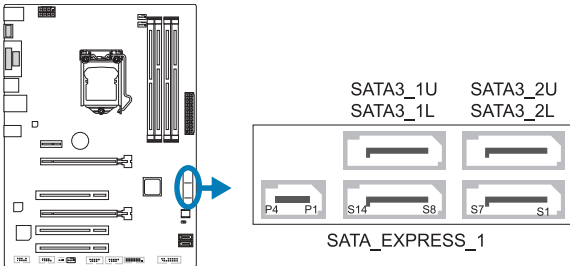

针	定义	针	定义
S1/S8	接地	P1	Reserved
S2/S9	TX+	P2	PERST#
S3/S10	TX-	P3	CLKREQ#/DEVSLP
S4/S11	接地	P4	IFDet
S5/S12	RX-		
S6/S13	RX+		
S7/S14	接地		

## SATA3\_3/3\_4: 串行ATA接口

此接口通过SATA数据线连接SATA硬盘。

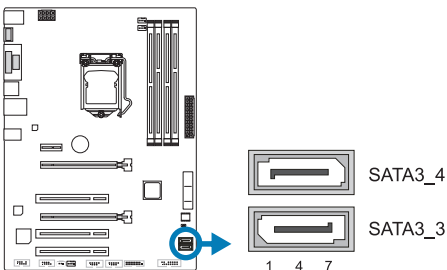

针	定义
1	接地
2	TX+
3	TX-
4	接地
5	RX-
6	RX+
7	接地

## JFRONT\_USB3\_1: 前置面板USB 3.0接头

PC前置面板支持附加的USB数据线，也可连接即插即用外围设备。

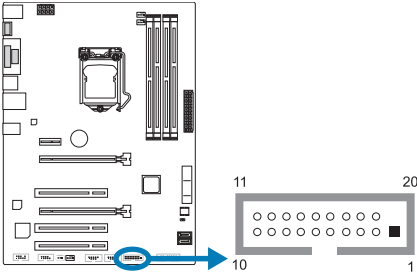

针	定义	针	定义
1	VBUS0	11	D2+
2	SSRX1-	12	D2-
3	SSRX1+	13	接地
4	接地	14	SSTX2+
5	SSTX1-	15	SSTX2-
6	SSTX1+	16	接地
7	接地	17	SSRX2+
8	D1-	18	SSRX2-
9	D1+	19	VBUS1
10	ID	20	Key

### Note

- » 此接口支持映泰Charger Booster II技术，可以缩减USB设备的充电时间。
- » 充电模式可以在BIOS设置菜单或Charger Booster II程序进行选择。

## F\_USB1/2: 前置面板USB 2.0接头

PC前置面板支持附加的USB数据线，也可连接即插即用外围设备。

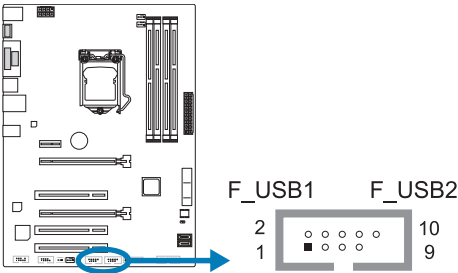

针	定义
1	+5V (fused)
2	+5V (fused)
3	USB-
4	USB-
5	USB+
6	USB+
7	接地
8	接地
9	Key
10	NC

## JSPDIFOUT1: 数字音频输出接口

此接口连接PCI支架SPDIF输出接头。

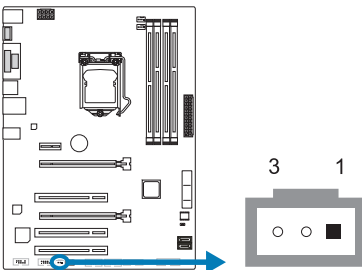

针	定义
1	+5V
2	SPDIF_OUT
3	接地

## F\_AUDIO1: 前置面板音频接头

此接头可连接音频输出数据线，支持HD(高清)音频和AC' 97。

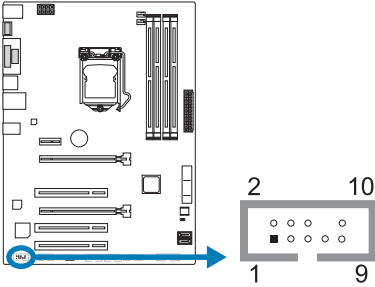

HD Audio		AC' 97	
针	定义	针	定义
1	Mic Left in	1	Mic In
2	接地	2	接地
3	Mic Right in	3	Mic Power
4	GPIO	4	Audio Power
5	Right line in	5	RT Line Out
6	Jack Sense	6	RT Line Out
7	Front Sense	7	Reserved
8	Key	8	Key
9	Left line in	9	LFT Line Out
10	Jack Sense	10	LFT Line Out

### 注意

- » 建议您连接前置高清音频插孔，享用主板高清音频功能。
- » 如果要连接AC' 97前置音频输出数据线，请关闭“前置面板插孔检测功能”。此功能在系统音频工具中可见。

## COM: 串行端口

此主板有一串行端口，可连接至RS-232端口。

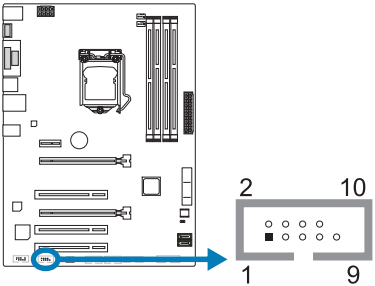

针	定义
1	Carrier detect
2	Received data
3	Transmitted data
4	Data terminal ready
5	Signal ground
6	Data set ready
7	Request to send
8	Clear to send
9	Ring indicator
10	Key

## 第三章: UEFI BIOS和软件

### 3.1 UEFI BIOS设置

- BIOS设置程序可用于查看和更改计算机的BIOS设置。开机自检时，按<DEL>键可进入BIOS设置程序。
- 更多相关UEFI BIOS设置信息，请参考网站上的UEFI BIOS手册。

### 3.2 刷新BIOS

以下任意一种工具都可以刷新BIOS:

- BIOSTAR BIOS Flasher: 使用此工具，BIOS可通过硬盘上的文件刷新，USB驱动刷新，或者CD-ROM刷新。
- BIOSTAR BIOS刷新工具: 能够在Windows环境下自动刷新。使用此工具，BIOS可通过硬盘上的文件刷新，USB驱动刷新，CD-ROM刷新或者从网站上的文件地址刷新。

#### BIOSTAR BIOS Flasher

##### 注意

- » 此工具仅允许可使用FAT32/16格式化或单个分区的存储设备。
- » 刷新BIOS时如关机或重启系统将导致系统引导失败。

使用BIOSTAR BIOS Flasher刷新BIOS

1. 进入网站下载与主板相匹配的最新BIOS文件。
2. 然后保存BIOS文件到U-盘。
3. 插入包含BIOS文件的U-盘到USB接口
4. 开机或重启后，在自检过程中按<F12>键。

5. 进入自检后，屏幕会弹出BIOS-FLASHER工具。选择<fs0>搜索BIOS文件。

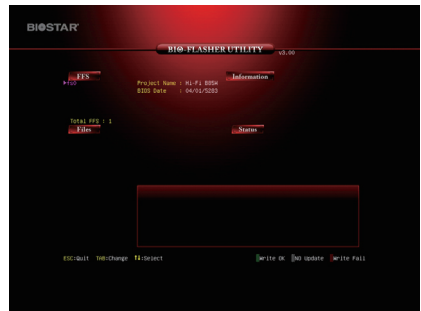

6. 选择合适的BIOS文件，并按“ Yes” 执行BIOS刷新程序。





7. BIOS刷新后会弹出是否重启系统的对话框。按<Y>重启系统

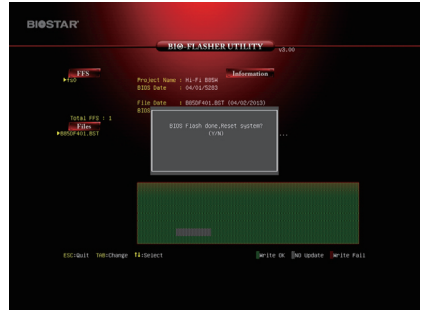

8. 系统引导并出现相关标识信息时，按<DEL>键进入BIOS设置。选择<Save & Exit>，使用<Restore Defaults>功能加载系统默认值，然后选择<Save Changes and Reset>来重启系统，完成BIOS刷新。

### BIOS刷新工具（通过网络）

1. 用DVD驱动安装BIOS Update Utility。
2. 使用此功能时，请确保电脑联网。

3. 打开BIOS刷新工具，然后点击“Online Update”按钮。



4. 屏幕弹出是否执行刷新BIOS程序的对话框，点击“ Yes”开始刷新BIOS。

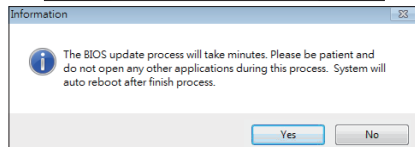

5. 如果BIOS有新版本，屏幕会弹出提示您下载最新版本的对话框。点击“ Yes”下载。

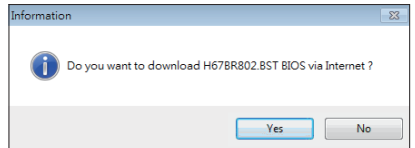

6. 完成下载后，屏幕弹出提示您刷新BIOS的对话框，点击“ Yes”开始刷新。

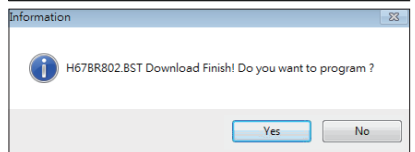

7. 刷新程序结束后，屏幕弹出提示您重启系统的对话框。点击“OK”重启系统。

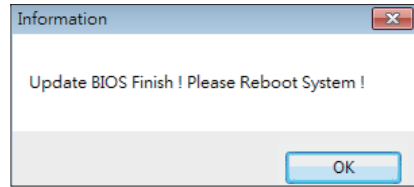

8. 系统引导并出现相关标识信息时，按<DEL>键进入BIOS设置。选择<Save & Exit>，使用<Restore Defaults>功能加载系统默认值，然后选择<Save Changes and Reset>来重启系统，完成BIOS刷新。

### BIOS刷新工具（通过BIOS文件）

1. 用DVD驱动安装BIOS刷新工具。
2. 从我们的网站[www.biostar.com.tw](http://www.biostar.com.tw) 下载合适的BIOS。

3. 在主页面打开BIOS Updat Utility，然后点击“Update BIOS”按钮。



4. 屏幕弹出是否执行刷新BIOS程序的对话框，点击“OK”开始刷新BIOS。

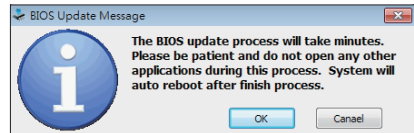

5. 选择BIOS文件的存放目录。然后选择合适的BIOS文件，点击“Open”。刷新BIOS要花几分钟时间，请耐心等待。

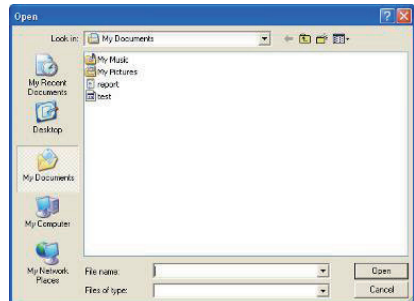

6. BIOS刷新过程结束后，点击“OK”重启系统。

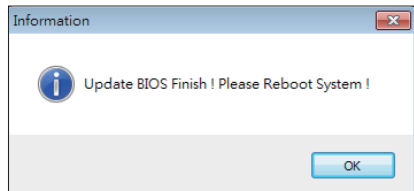

7. 系统引导并出现相关标识信息时，按<DEL>键进入BIOS设置。  
选择<Save & Exit>，使用<Restore Defaults>功能加载系统默认值，然后选择<Save Changes and Reset>来重启系统，完成BIOS刷新。

### BIOS备份

点击BIOS备份按钮，选择存储备份文件的合适目录，然后点击“ Save”。

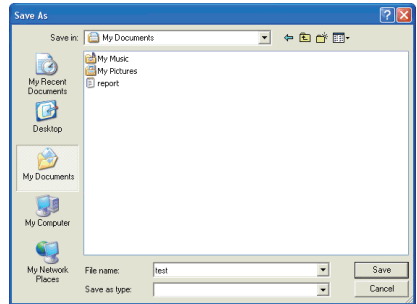

### 3.3 软件

#### 安装软件

1. 将光盘放入光驱，若Autorun功能已激活，驱动安装程序将会出现。
2. 选择Software Installation，然后点击各软件图标。
3. 根据屏幕上的指令完成安装。

#### 启动软件

安装程序完成后，桌面上将出现软件图标。请双击图标启动软件工具。

#### 注意

- » 所有软件的相关信息和内容若有变更，恕不另行通知。为使系统性能更佳，软件会不断升级。
- » 下面的图片和信息仅供参考，此主板的实际信息和设置可能与手册稍有差异。

#### BIOScreen 工具

此实用工具可以将开机画面个性化。您可以选择BMP格式来自定义计算机开机画面。



请参照以下步骤来更新开机画面：

- 加载画面(Load Image): 选择图片作为开机画面。
- 转换(Transform): 转换图片并预览。
- 更新BIOS(Update Bios): 将图片写入BIOS内存，然后完成更新。

## Charger Booster II

映泰Charger Booster II技术可以縮減USB供电设备的充电时间。安装Charger Booster II后，程序将出现在Windows通知区域。用鼠标右键单击该程序图标可以选择CDP模式（充电下行端口）或DCP模式（专用的充电端口）为您的USB设备供电。

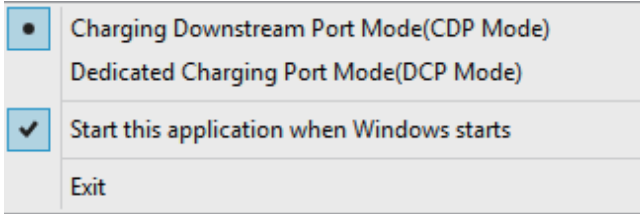

### 注意

» 请参考附录II的USB供电的设备兼容列表。

## eHot-Line

eHot-Line是有助于您联系技术支持系统的便捷工具。此工具将收集系统信息，当您遇到问题时，可提供有利分析，并发送这些信息至我们的技术支持部门，从而帮助解决这个问题。

\*represents important information that you must provide. Without this information, you may not be able to send out the mail.

This block will show the information which would be collected in the mail.

\*Describe condition of your system.

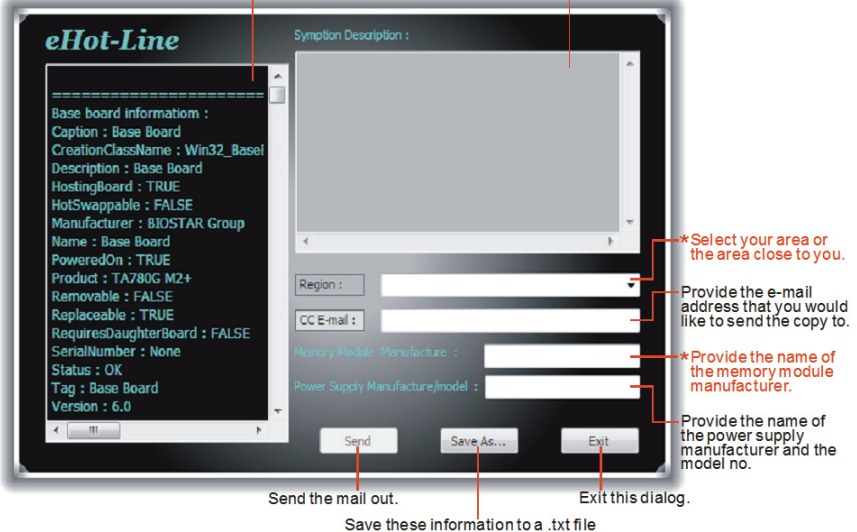



## Green Power II Utility

BIOSTAR G.P.U II (绿色节能工具)是一种新的功能。当CPU低负荷加载时此工具可以通过关闭额外的相位来提高节能效率。BIOSTAR G.P.U II集成了友好的图形界面来监视CPU使用率、CPU功率和CPU温度，并且可以为您的系统优化省电，提供最佳的功率。(下图仅供参考)

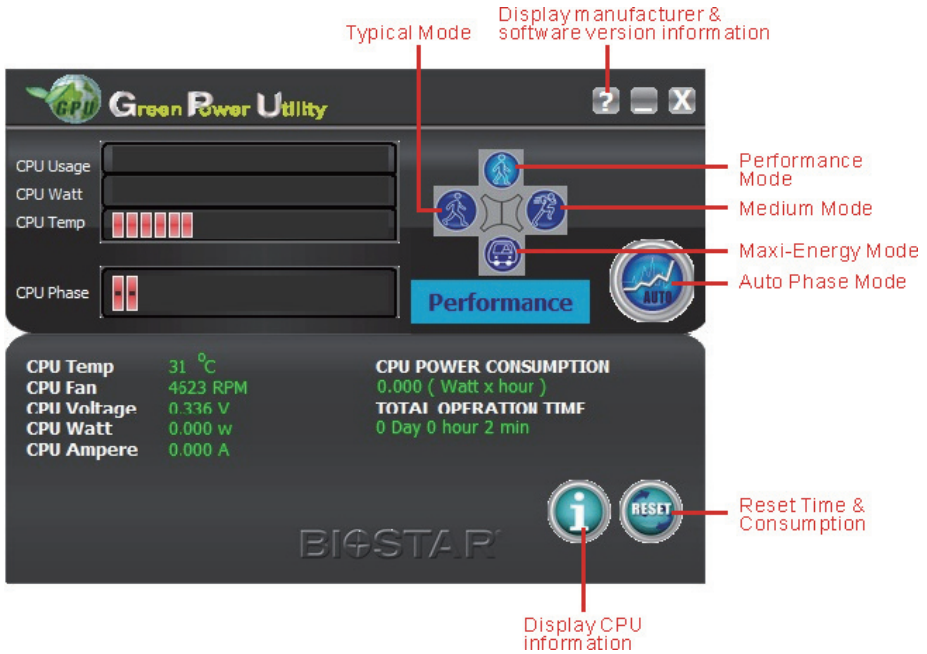

### G.P.U 模式设置:

此工具提供5种模式，根据您的所需来提高系统性能或者节省耗电量。

#### 注意

» 即使选择节省更多耗电量模式，系统同样可以维持最佳的性能。

- Auto Phase Mode: 系统根据当前加载情况自动调节模式。
- Performance Mode: 此模式为最少耗电模式，系统消耗最少的能量。
- Typical Mode: 此模式与最少耗电模式相比，消耗较多能量。
- Medium Mode: 此模式为标准省电模式。
- Maxi-Energy Mode: 此模式为最佳系统性能模式。

## 智能耳放增效Smart EAR

### Hi-Fi音频要求:

1. 带有前置音频输出插孔的机箱。
2. 耳机或头戴式耳机。
3. Windows 7/ 8.1(64bit)/ 10(64bit)操作系统。

### 安装指南:

1. 确保机箱前置音频线正确连接至主板上的前置音频接头。
2. 从驱动DVD上安装智能耳放3D实用工具。
3. 将耳机或头戴式耳机连接至机箱前置音频插孔或后部的音频输出接口，启用智能增益和3d声场功能。

### 注意

» 如果您想使用AC' 97前置音频输出线，请禁用“前置面板插孔检测功能”。此功能在系统音频工具中可见。

### 智能耳放增效工具:



- 高低增益开关: 使用低阻抗耳机时调至低 ( LO )，使用高阻抗耳机时调至高 ( HI )。
- 静音按钮: 可切换到静音状态。
- 音量调节旋钮: 可调节音量大小。
- 信息按钮: 获取应用信息按钮。
- 最小化按钮: 将此应用窗口最小化至任务栏。
- 退出按钮: 退出应用



## 第四章:帮助信息

### 4.1 驱动程序安装注意事项

为获得更好的系统性能，在操作系统安装完成后，请插入您的系统驱动到光驱并安装。插入DVD后，将出现如下所示窗口。



此设置向导将自动检测您的主板和操作系统。

#### **A. 驱动程序安装**

安装驱动程序，请点击驱动器图标。设置向导将列出主板兼容驱动和操作系统。点击各设备驱动程序，以开始安装进程。

#### **B. 软件安装**

安装软件，请点击软件图标。设置向导将列出系统可用软件，点击各软件名称，以开始安装进程。

#### **C. 使用手册**

除了书本形式的手册，我们也提供光盘形式的使用指南。点击Manual图标，浏览可用相关使用指南。

#### **注意**

- » 在插入驱动之后，如此窗口未出现，请用文件浏览器查找并执行SETUP.EXE文件。
- » 若需要Acrobat Reader打开manual文件。请从网站<http://get.adobe.com/reader/>下载最新版本的Acrobat Reader软件。

## 4.2 AMI BIOS 哔声代码

### 引导模块哔声代码

哔声次数	含义
持续哔声	持续哔声

### BIOS 开机自检哔声代码

哔声次数	含义
1	系统引导成功
8	显存错误(系统视频适配器)

## 4.3 AMI BIOS 开机自检代码

代码	含义
10	PEI核心启动
11	CPU Pre-memory初始化启动
15	北桥Pre-memory初始化启动
19	南桥Pre-memory初始化启动
2B	内存初始化·读取SPD数据
2C	内存初始化·检测Memory presence
2D	内存初始化·编程内存时序信息
2E	内存初始化·配置内存
2F	内存初始化(其他)
31	内存安装完成
32	CPU post-memory初始化启动
33	CPU post-memory初始化·Cache初始化
34	CPU post-memory初始化·应用处理器初始化
35	CPU post-memory初始化·选择BSP
36	CPU post-memory初始化·系统管理模式初始化
37	北桥Post-Memory初始化启动
3B	北桥Post-Memory初始化
4F	DXE IPL启动
60	DXE核心启动
F0	固件引起的恢复条件(自动恢复)
F1	用户引起的恢复条件(强制恢复)
F2	恢复进程启动
F3	找到固件恢复图象
F4	加载固件恢复图象
E0	S3唤醒启动
E1	执行S3启动脚本
E2	重新发送影像
E3	系统S3待机导向
60	DXE内核启动
61	NVRAM初始化
62	安装南桥运行期
63	CPU DXE初始化启动
68	PCI HB初始化
69	北桥DXE初始化
6A	北桥DXE SMM初始化启动

代码	含义
70	南桥DXE初始化启动
71	南桥DXE SMM初始化启动
72	南桥设备初始化
78	南桥DXE初始化
79	ACPI模组初始化
90	引导设备选择阶段启动
91	驱动连接启动
92	PCI总线初始化启动
93	PCI总线热拔插控制器初始化
94	PCI总线列举
95	PCI总线请求资源
96	PCI总线分配资源
97	控制台输出设备连接
98	控制台输入设备连接
99	高级IO初始化
9A	USB初始化启动
9B	USB复位
9C	USB检测
9D	USB启用
A0	IDE初始化启动
A1	IDE复位
A2	IDE检测
A3	IDE启用
A4	SCSI初始化启动
A5	SCSI复位
A6	SCSI检测
A7	SCSI启用
A8	设置校对密码
A9	设置开始
AB	设置输入等待
AD	准备启动环境
AE	传统启动环境
AF	退出启动环境
B0	虚拟地址图开始
B1	虚拟地址图结束
B2	传统可选ROM初始化
B3	系统复位
B4	USB热拔插
B5	PCI总线热拔插
B6	清理NVRAM
B7	配置复位(NVRAM设置复位)

**注意**

» 如此窗若出现表格未列出的代码，请联系我们的技术支持。

## 4.4 问题解答

问题	解决方法
1. 系统没有电，电源指示灯不亮，电源风扇不转动。 2. 键盘上的指示灯不亮。	1. 确定电源线是否接好。 2. 更换线材。 3. 联系技术支持。
系统不起作用。键盘指示灯亮，电源指示灯亮，硬盘正常运作。	用力按压内存两端，确保内存安置于插槽中。
系统不能从硬盘启动，能从光盘启动。	1. 检查硬盘与主板的连线，确定各连线是否确实接好，检查标准CMOS设置中的驱动类型。 2. 硬盘随时都有可能坏掉，所以备份硬盘数据是很重要的。
系统只能从光盘启动。硬盘能被读，应用程序能被使用，但是不能从硬盘启动。	1. 备份数据和应用程序。 2. 重新格式化硬盘。用后备盘重新安装应用程序和数据。
屏幕提示“Invalid Configuration”或“CMOS Failure”。 再次检查系统设备，确定设定是否正确安装了第二个硬盘	再次检查系统设备，确定设定是否正确
安装了第二个硬盘后，系统不能启动。	1. 正确设置主/从硬盘跳线。 2. 运行安装程序，选择正确的驱动类型。与驱动器厂商联系，寻求驱动兼容性的技术支持。

### CPU过热保护系统

在开启系统数秒后如有自动关机的现象，这说明CPU保护功能已被激活。CPU过热时，防止损坏CPU，主机将自动关机，系统则无法重启。

此种情况下，请仔细检查。

1. CPU 散热器平放在CPU表面。
2. CPU风扇能正常旋转。
3. CPU风扇旋转速度与CPU运行速度相符。

确认后，请按以下步骤缓解CPU保护功能。

1. 切断电源数秒。
2. 等待几秒钟。
3. 插上电源开启系统。

或是：

1. 清除CMOS数据。(查看“Close CMOS Header: JCMOS1”部分)
2. 等待几秒钟。
3. 重启系统。

## 4.5 RAID 功能

### RAID 定义

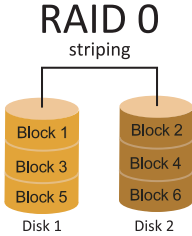

创建带区集，在同一时间内向多块磁盘写入数据，通过把数据分成多个数据块（Block）并行写入/读出多个磁盘以提高访问磁盘的速度分散到所有的硬盘中同时进行读写，在整个磁盘阵列建立过程中，以系统环境为基础，指数的大小决定了每块磁盘的容量。此技术可减少整个磁盘的存取时间和提供高速带宽。

### 性能及优点

- 驱动器: 最少2块硬盘，最多达6块或8块，取决于平台。
- Uses: 使用RAID 0来提高磁盘的性能和吞吐量，但没有冗余或错误修复能力。
- 优点: 增加磁盘的容量。
- 缺点: 整个系统是非常不可靠的，如果出现故障，无法进行任何补救。整个数据都会丢失。
- 容错: 否。

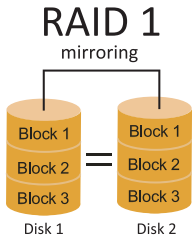

每次读写实际上是在磁盘阵列系统中(RAID 1)，通过2个磁盘驱动器并行完成的。RAID 1或镜像模式能够自动对数据进行备份，通过将一块硬盘中的数据完整复制到另外一块硬盘实现数据的冗余。假如由于硬盘的损坏，导致驱动失败，或是容量过大，RAID1可以提供一个数据备份。RAID 技术可以应用于高效方案，或者可以作为自动备份形式，代替冗长的，高价的且不稳定的备份形式。

### 性能及优点

- 驱动器: 最少2块硬盘，最多2块。
- 使用: RAID 1是理想的小型数据库储备器或应用在有容错能力和小容量方面。
- 优点: 提供100%的数据冗余。即使一个磁盘控制器出现问题，系统仍然可以使用另外一个磁盘控制器继续工作。
- 缺点: 2个驱动器替代一个驱动器储存的空间，在驱动重建期间系统的性能有所下降。
- 容错: 是。

## RAID 10 (1+0)

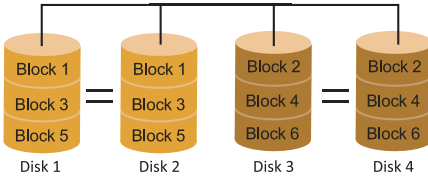

RAID 10模式是对RAID 0/ RAID 1两种不同模式的结合，可以同时支持带区集和镜像，这样既可以提升速度又可以加强数据的安全性。

### 性能及优点

- 驱动器: 最少4块硬盘，最多6或8块。
- 优点: 容量和性能的优化允许冗余的自动化。在一个阵列，可以同时使用其它的RAID，并允许剩余的磁盘。
- 缺点: 数据冗余需要两倍可用磁盘空间，与RAID1相同。
- 容错: 是。

## RAID 5

parity across disks

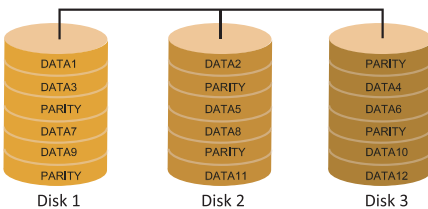

RAID 5数据块和奇偶块信息跨3块或更多块驱动器。奇偶校验数据分散分布在磁盘阵列的全部硬盘。容错的维护是由确保数据块传输奇偶块信息实现的，此信息被放置在不同于那些自身可以储存信息的驱动盘里。

### 性能及优点

- 驱动器: 最少3块硬盘。
- 使用: RAID 5被推荐用于处理交易和普通操作服务。
- 优点: 一个理想的最佳性能的结合，最佳容错，大容量和最快存储效率。
- 缺点: 个别资料区块的传输速率和单一硬盘相同，写入的效能会取决于CPU的速度。
- 容错: 是。

### 注意

» 请访问网站[http://www.intel.com/p/en\\_US/support/highlights/chpsts/imsm](http://www.intel.com/p/en_US/support/highlights/chpsts/imsm)获取(Intel® RST)英特尔快速存储技术的相关资料。

## 附录I：产品中有毒有害物质或元素的名称及含量

部件名称	有毒有害物质或元素					
	铅 (Pb)	汞 (Hg)	镉 (Cd)	六价铬 (Cr(VI))	多溴联苯 (PBB)	多溴二苯醚 (PBDE)
PCB板	○	○	○	○	○	○
结构件	○	○	○	○	○	○
芯片及其它主动零件	X	○	○	○	○	○
连接器	X	○	○	○	○	○
被动电子元器件	X	○	○	○	○	○
焊接金属	○	○	○	○	○	○
线材	○	○	○	○	○	○
助焊剂·散热膏·标签及其它耗材	○	○	○	○	○	○

○：表示该有毒有害物质在该部件所有均质材料中的含量在SJ/T11363-2006标准规定的限量要求以下。

X：表示该有毒有害物质至少在该部件的某一均质材料中的含量超出SJ/T11363-2006标准规定的限量要求。

备注：在芯片及其它主动零件、连接器、被动电子元器件Pb栏位中有打X，表示Pb在该部件的某一均质材料中的含量超出SJ/T11363-2006标准规定的限量要求，但均符合欧盟ROHS指令豁免条款。

## 附录II : Charger Boost II 设备兼容列表

	键盘/鼠标		手机		苹果设备		平板
1	Acer USB mouse	1	HTC Sensation	1	Apple iPhone6	1	Lenovo Table A1
2	Caibo USB mouse	2	HTC ONEX	2	Apple iPhone5	2	Nexus 7 3G version
3	KINYO USB mouse	3	HTC J	3	Apple iPhone4	3	Nexus 7 2013 wifi version
4	KINYO USB keyboard	4	HTC Desire 600	4	Apple iPhone3GS	4	Samsung note 10.1
5	M5 USB mouse	5	HTC M7	5	Apple iPod 20G		
6	Logitech wireless USB mouse	6	LG G2	6	Apple iPhone 4S		
		7	LG G3	7	Apple iPad		
		8	Lenovo Lephone S2	8	Apple iPad2		
		9	Samsung S2	9	Apple new iPad		
		10	Samsung Note	10	Apple iPad4		
		11	Samsung S3	11	Apple iPad air		
		12	Samsung ACE	12	Apple iPad mini		
		13	Samsung Note3				
		14	Mi 3				
		15	Sony Z				